



OM-356

188694W

April 2003

**Processes**



TIG (GTAW) Welding



Stick (SMAW) Welding

**Description**



Arc Welding Power Source

# Syncrowave<sup>®</sup> 350 LX

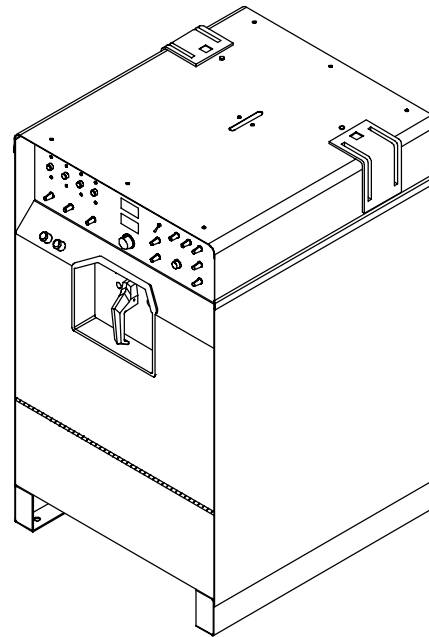

**CE** And Non-CE Models



Visit our website at  
[www.MillerWelds.com](http://www.MillerWelds.com)

## OWNER'S MANUAL

# From Miller to You

*Thank you and congratulations* on choosing Miller. Now you can get the job done and get it done right. We know you don't have time to do it any other way.

That's why when Niels Miller first started building arc welders in 1929, he made sure his products offered long-lasting value and superior quality. Like you, his customers couldn't afford anything less. Miller products had to be more than the best they could be. They had to be the best you could buy.

Today, the people that build and sell Miller products continue the tradition. They're just as committed to providing equipment and service that meets the high standards of quality and value established in 1929.

This Owner's Manual is designed to help you get the most out of your Miller products. Please take time to read the Safety precautions. They will help you protect yourself against potential hazards on the worksite.

We've made installation and operation quick and easy. With Miller you can count on years of reliable service with proper maintenance. And if for some reason the unit needs repair, there's a Troubleshooting section that will help you figure out what the problem is. The parts list will then help you to decide the exact part you may need to fix the problem. Warranty and service information for your particular model are also provided.



Miller is the first welding equipment manufacturer in the U.S.A. to be registered to the ISO 9001:2000 Quality System Standard.

Miller Electric manufactures a full line of welders and welding related equipment. For information on other quality Miller products, contact your local Miller distributor to receive the latest full line catalog or individual catalog sheets. **To locate your nearest distributor or service agency call 1-800-4-A-Miller, or visit us at [www.MillerWelds.com](http://www.MillerWelds.com) on the web.**



Working as hard as you do – every power source from Miller is backed by the most hassle-free warranty in the business.

*Miller offers a Technical Manual which provides more detailed service and parts information for your unit. To obtain a Technical Manual, contact your local distributor. Your distributor can also supply you with Welding Process Manuals such as SMAW, GTAW, GMAW, and GMAW-P.*



# TABLE OF CONTENTS

The following terms are used interchangeably throughout this manual:  
TIG = GTAW  
Stick = SMAW

## **WARNING**

This product, when used for welding or cutting, produces fumes or gases which contain chemicals known to the State of California to cause birth defects and, in some cases, cancer. (California Health & Safety Code Section 25249.5 et seq.)

<b>SECTION 1 – SAFETY PRECAUTIONS - READ BEFORE USING</b> .....	<b>1</b>
1-1. Symbol Usage .....	1
1-2. Arc Welding Hazards .....	1
1-3. Additional Symbols for Installation, Operation, and Maintenance .....	3
1-4. Principal Safety Standards .....	3
1-5. EMF Information .....	4
<b>SECTION 1 – CONSIGNES DE SECURITE – LIRE AVANT UTILISATION</b> .....	<b>5</b>
1-1. Signification des symboles .....	5
1-2. Dangers relatifs au soudage à l'arc .....	5
1-3. Dangers supplémentaires en relation avec l'installation, le fonctionnement et la maintenance .....	7
1-4. Principales normes de sécurité .....	8
1-5. Information sur les champs électromagnétiques .....	8
<b>SECTION 2 – DEFINITIONS</b> .....	<b>9</b>
2-1. Warning Label Definitions .....	9
2-2. Manufacturer's Rating Label For CE Products .....	11
2-3. Symbols And Definitions .....	12
<b>SECTION 3 – INSTALLATION</b> .....	<b>13</b>
3-1. Selecting A Location .....	13
3-2. Dimensions And Weights .....	14
3-3. Specifications .....	14
3-4. Duty Cycle And Overheating .....	15
3-5. Volt-Ampere Curves .....	15
3-6. Weld Output Terminals And Selecting Cable Sizes .....	16
3-7. Remote 14 Receptacle .....	16
3-8. Shielding Gas Connections And 115 Volts AC Duplex Receptacle .....	17
3-9. Electrical Service Guide .....	18
3-10. Placing Jumper Links .....	19
3-11. Connecting Input Power .....	20
<b>SECTION 4 – OPERATION</b> .....	<b>21</b>
4-1. Controls .....	21
4-2. Output Selector Switch .....	23
4-3. Process Control .....	23
4-4. Current Control .....	24
4-5. Output Control .....	24
4-6. Start Mode .....	25
4-7. Meters .....	26
4-8. Amperage Adjustment Control .....	26
4-9. Balance/DIG Control .....	27
4-10. Preflow Time Control .....	27
4-11. Postflow Time Control .....	28
4-12. Setting Pulse Controls .....	29
4-13. Optional Sequence Controls .....	30
4-14. Sequence Selection Switch .....	30
4-15. Start Time/Spot Time Control And Start Current Control .....	31
4-16. Crater Time Control And Final Current Control .....	32
4-17. Start/Crater Sequence Controls .....	33
4-18. 4T Sequence Selection Controls .....	34
4-19. Spot Time Control .....	35
4-20. Timer/Cycle Counter .....	35
<b>SECTION 5 – MAINTENANCE &amp; TROUBLESHOOTING</b> .....	<b>36</b>
5-1. Routine Maintenance .....	36
5-2. Circuit Breaker CB1 .....	36
5-3. Adjusting Spark Gaps .....	37
5-4. Voltmeter/Ammeter Help Displays .....	38
5-5. Troubleshooting .....	39
<b>SECTION 6 – ELECTRICAL DIAGRAM</b> .....	<b>41</b>
<b>SECTION 7 – HIGH FREQUENCY</b> .....	<b>42</b>
<b>SECTION 8 – PARTS LIST</b> .....	<b>44</b>
<b>OPTIONS AND ACCESSORIES</b>	
<b>WARRANTY</b>	

# Declaration of Conformity For European Community (CE) Products

**NOTE** 

*This information is provided for units with CE certification (see rating label on unit.)*

*Manufacturer's Name:* **Miller Electric Mfg. Co.**

*Manufacturer's Address:* 1635 W. Spencer Street  
Appleton, WI 54914 USA

*Declares that the product:* **Syncrowave® 350LX**

*conforms to the following Directives and Standards:*

### Directives

*Low Voltage Directive: 73/23/EEC*

*Machinery Directives: 89/392/EEC, 91/368/EEC, 93/C 133/04, 93/68/EEC*

*Electromagnetic Capability Directives: 89/336, 92/31/EEC*

### Standards

*Safety Requirements for Arc Welding Equipment part 1: EN 60974-1: 1990*

*Arc Welding Equipment Part 1: Welding Power Sources: IEC 60974-1  
(November 1997 – Draft revision)*

*Degrees of Protection provided by Enclosures (IP code): IEC 529: 1989*

*Insulation coordination for equipment within low-voltage systems:  
Part 1: Principles, requirements and tests: IEC 664-1: 1992*

*Electromagnetic compatibility (EMC) Product standard for arc welding equipment:  
EN50199: August 1995*

*European Contact:* Mr. Danilo Fedolfi, Managing Director  
ITW WELDING PRODUCTS ITALY S.r.l.  
Via Privata Iseo 6/E  
20098 San Giuliano  
Milanese, Italy

*Telephone:* 39(02)98290-1  
*Fax:* 39(02)98290-203

# SECTION 1 – SAFETY PRECAUTIONS - READ BEFORE USING

som\_nd\_7/02

## 1-1. Symbol Usage



Means Warning! Watch Out! There are possible hazards with this procedure! The possible hazards are shown in the adjoining symbols.

▲ Marks a special safety message.

☞ Means "Note"; not safety related.



This group of symbols means Warning! Watch Out! possible ELECTRIC SHOCK, MOVING PARTS, and HOT PARTS hazards. Consult symbols and related instructions below for necessary actions to avoid the hazards.

## 1-2. Arc Welding Hazards

▲ The symbols shown below are used throughout this manual to call attention to and identify possible hazards. When you see the symbol, watch out, and follow the related instructions to avoid the hazard. The safety information given below is only a summary of the more complete safety information found in the Safety Standards listed in Section 1-4. Read and follow all Safety Standards.

▲ Only qualified persons should install, operate, maintain, and repair this unit.

▲ During operation, keep everybody, especially children, away.



### ELECTRIC SHOCK can kill.

Touching live electrical parts can cause fatal shocks or severe burns. The electrode and work circuit is electrically live whenever the output is on. The input power circuit and machine internal circuits are also

live when power is on. In semiautomatic or automatic wire welding, the wire, wire reel, drive roll housing, and all metal parts touching the welding wire are electrically live. Incorrectly installed or improperly grounded equipment is a hazard.

- Do not touch live electrical parts.
- Wear dry, hole-free insulating gloves and body protection.
- Insulate yourself from work and ground using dry insulating mats or covers big enough to prevent any physical contact with the work or ground.
- Do not use AC output in damp areas, if movement is confined, or if there is a danger of falling.
- Use AC output ONLY if required for the welding process.
- If AC output is required, use remote output control if present on unit.
- Disconnect input power or stop engine before installing or servicing this equipment. Lockout/tagout input power according to OSHA 29 CFR 1910.147 (see Safety Standards).
- Properly install and ground this equipment according to its Owner's Manual and national, state, and local codes.
- Always verify the supply ground – check and be sure that input power cord ground wire is properly connected to ground terminal in disconnect box or that cord plug is connected to a properly grounded receptacle outlet.
- When making input connections, attach proper grounding conductor first – double-check connections.
- Frequently inspect input power cord for damage or bare wiring – replace cord immediately if damaged – bare wiring can kill.
- Turn off all equipment when not in use.
- Do not use worn, damaged, undersized, or poorly spliced cables.
- Do not drape cables over your body.

- If earth grounding of the workpiece is required, ground it directly with a separate cable.
- Do not touch electrode if you are in contact with the work, ground, or another electrode from a different machine.
- Use only well-maintained equipment. Repair or replace damaged parts at once. Maintain unit according to manual.
- Wear a safety harness if working above floor level.
- Keep all panels and covers securely in place.
- Clamp work cable with good metal-to-metal contact to workpiece or worktable as near the weld as practical.
- Insulate work clamp when not connected to workpiece to prevent contact with any metal object.
- Do not connect more than one electrode or work cable to any single weld output terminal.

### SIGNIFICANT DC VOLTAGE exists after removal of input power on inverters.

- Turn Off inverter, disconnect input power, and discharge input capacitors according to instructions in Maintenance Section before touching any parts.

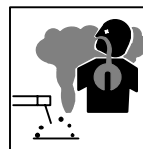

### FUMES AND GASES can be hazardous.

Welding produces fumes and gases. Breathing these fumes and gases can be hazardous to your health.

- Keep your head out of the fumes. Do not breathe the fumes.
- If inside, ventilate the area and/or use exhaust at the arc to remove welding fumes and gases.
- If ventilation is poor, use an approved air-supplied respirator.
- Read the Material Safety Data Sheets (MSDSs) and the manufacturer's instructions for metals, consumables, coatings, cleaners, and degreasers.
- Work in a confined space only if it is well ventilated, or while wearing an air-supplied respirator. Always have a trained watch-person nearby. Welding fumes and gases can displace air and lower the oxygen level causing injury or death. Be sure the breathing air is safe.
- Do not weld in locations near degreasing, cleaning, or spraying operations. The heat and rays of the arc can react with vapors to form highly toxic and irritating gases.
- Do not weld on coated metals, such as galvanized, lead, or cadmium plated steel, unless the coating is removed from the weld area, the area is well ventilated, and if necessary, while wearing an air-supplied respirator. The coatings and any metals containing these elements can give off toxic fumes if welded.



### ARC RAYS can burn eyes and skin.

Arc rays from the welding process produce intense visible and invisible (ultraviolet and infrared) rays that can burn eyes and skin. Sparks fly off from the weld.

- Wear a welding helmet fitted with a proper shade of filter to protect your face and eyes when welding or watching (see ANSI Z49.1 and Z87.1 listed in Safety Standards).
- Wear approved safety glasses with side shields under your helmet.
- Use protective screens or barriers to protect others from flash and glare; warn others not to watch the arc.
- Wear protective clothing made from durable, flame-resistant material (leather and wool) and foot protection.



### WELDING can cause fire or explosion.

Welding on closed containers, such as tanks, drums, or pipes, can cause them to blow up. Sparks can fly off from the welding arc. The flying sparks, hot workpiece, and hot equipment can cause fires and burns. Accidental contact of electrode to metal objects can cause sparks, explosion, overheating, or fire. Check and be sure the area is safe before doing any welding.

- Protect yourself and others from flying sparks and hot metal.
- Do not weld where flying sparks can strike flammable material.
- Remove all flammables within 35 ft (10.7 m) of the welding arc. If this is not possible, tightly cover them with approved covers.
- Be alert that welding sparks and hot materials from welding can easily go through small cracks and openings to adjacent areas.
- Watch for fire, and keep a fire extinguisher nearby.
- Be aware that welding on a ceiling, floor, bulkhead, or partition can cause fire on the hidden side.
- Do not weld on closed containers such as tanks, drums, or pipes, unless they are properly prepared according to AWS F4.1 (see Safety Standards).
- Connect work cable to the work as close to the welding area as practical to prevent welding current from traveling long, possibly unknown paths and causing electric shock and fire hazards.
- Do not use welder to thaw frozen pipes.
- Remove stick electrode from holder or cut off welding wire at contact tip when not in use.
- Wear oil-free protective garments such as leather gloves, heavy shirt, cuffless trousers, high shoes, and a cap.
- Remove any combustibles, such as a butane lighter or matches, from your person before doing any welding.

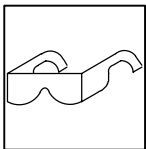

### FLYING METAL can injure eyes.

- Welding, chipping, wire brushing, and grinding cause sparks and flying metal. As welds cool, they can throw off slag.
- Wear approved safety glasses with side shields even under your welding helmet.



### BUILDUP OF GAS can injure or kill.

- Shut off shielding gas supply when not in use.
- Always ventilate confined spaces or use approved air-supplied respirator.



### HOT PARTS can cause severe burns.

- Do not touch hot parts bare handed.
- Allow cooling period before working on gun or torch.

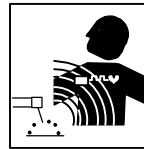

### MAGNETIC FIELDS can affect pacemakers.

- Pacemaker wearers keep away.
- Wearers should consult their doctor before going near arc welding, gouging, or spot welding operations.

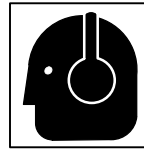

### NOISE can damage hearing.

Noise from some processes or equipment can damage hearing.

- Wear approved ear protection if noise level is high.

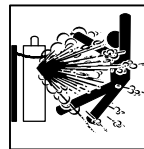

### CYLINDERS can explode if damaged.

Shielding gas cylinders contain gas under high pressure. If damaged, a cylinder can explode. Since gas cylinders are normally part of the welding process, be sure to treat them carefully.

- Protect compressed gas cylinders from excessive heat, mechanical shocks, slag, open flames, sparks, and arcs.
- Install cylinders in an upright position by securing to a stationary support or cylinder rack to prevent falling or tipping.
- Keep cylinders away from any welding or other electrical circuits.
- Never drape a welding torch over a gas cylinder.
- Never allow a welding electrode to touch any cylinder.
- Never weld on a pressurized cylinder – explosion will result.
- Use only correct shielding gas cylinders, regulators, hoses, and fittings designed for the specific application; maintain them and associated parts in good condition.
- Turn face away from valve outlet when opening cylinder valve.
- Keep protective cap in place over valve except when cylinder is in use or connected for use.
- Read and follow instructions on compressed gas cylinders, associated equipment, and CGA publication P-1 listed in Safety Standards.

## 1-3. Additional Symbols For Installation, Operation, And Maintenance



### FIRE OR EXPLOSION hazard.

- Do not install or place unit on, over, or near combustible surfaces.
- Do not install unit near flammables.
- Do not overload building wiring – be sure power supply system is properly sized, rated, and protected to handle this unit.



### MOVING PARTS can cause injury.

- Keep away from moving parts such as fans.
- Keep all doors, panels, covers, and guards closed and securely in place.



### FALLING UNIT can cause injury.

- Use lifting eye to lift unit only, NOT running gear, gas cylinders, or any other accessories.
- Use equipment of adequate capacity to lift and support unit.
- If using lift forks to move unit, be sure forks are long enough to extend beyond opposite side of unit.

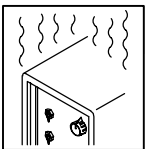

### OVERUSE can cause OVERHEATING

- Allow cooling period; follow rated duty cycle.
- Reduce current or reduce duty cycle before starting to weld again.
- Do not block or filter airflow to unit.

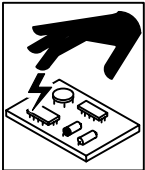

### STATIC (ESD) can damage PC boards.

- Put on grounded wrist strap BEFORE handling boards or parts.
- Use proper static-proof bags and boxes to store, move, or ship PC boards.



### MOVING PARTS can cause injury.

- Keep away from moving parts.
- Keep away from pinch points such as drive rolls.



### WELDING WIRE can cause injury.

- Do not press gun trigger until instructed to do so.
- Do not point gun toward any part of the body, other people, or any metal when threading welding wire.

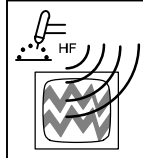

### H.F. RADIATION can cause interference.

- High-frequency (H.F.) can interfere with radio navigation, safety services, computers, and communications equipment.
- Have only qualified persons familiar with electronic equipment perform this installation.
- The user is responsible for having a qualified electrician promptly correct any interference problem resulting from the installation.
- If notified by the FCC about interference, stop using the equipment at once.
- Have the installation regularly checked and maintained.
- Keep high-frequency source doors and panels tightly shut, keep spark gaps at correct setting, and use grounding and shielding to minimize the possibility of interference.

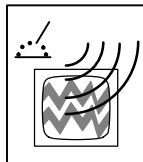

### ARC WELDING can cause interference.

- Electromagnetic energy can interfere with sensitive electronic equipment such as computers and computer-driven equipment such as robots.
- Be sure all equipment in the welding area is electromagnetically compatible.
- To reduce possible interference, keep weld cables as short as possible, close together, and down low, such as on the floor.
- Locate welding operation 100 meters from any sensitive electronic equipment.
- Be sure this welding machine is installed and grounded according to this manual.
- If interference still occurs, the user must take extra measures such as moving the welding machine, using shielded cables, using line filters, or shielding the work area.

## 1-4. Principal Safety Standards

*Safety in Welding, Cutting, and Allied Processes*, ANSI Standard Z49.1, from American Welding Society, 550 N.W. LeJeune Rd, Miami FL 33126 (phone: 305-443-9353, website: [www.aws.org](http://www.aws.org)).

*Recommended Safe Practices for the Preparation for Welding and Cutting of Containers and Piping*, American Welding Society Standard AWS F4.1, from American Welding Society, 550 N.W. LeJeune Rd, Miami, FL 33126 (phone: 305-443-9353, website: [www.aws.org](http://www.aws.org)).

*National Electrical Code*, NFPA Standard 70, from National Fire Protection Association, P.O. Box 9101, 1 Battery March Park, Quincy, MA 02269-9101 (phone: 617-770-3000, website: [www.nfpa.org](http://www.nfpa.org) and [www.sparky.org](http://www.sparky.org)).

*Safe Handling of Compressed Gases in Cylinders*, CGA Pamphlet P-1, from Compressed Gas Association, 1735 Jefferson Davis Highway, Suite 1004, Arlington, VA 22202-4102 (phone: 703-412-0900, website: [www.cganet.com](http://www.cganet.com)).

*Code for Safety in Welding and Cutting*, CSA Standard W117.2, from Canadian Standards Association, Standards Sales, 178 Rexdale

Boulevard, Rexdale, Ontario, Canada M9W 1R3 (phone: 800-463-6727 or in Toronto 416-747-4044, website: [www.csa-international.org](http://www.csa-international.org)).

*Practice For Occupational And Educational Eye And Face Protection*, ANSI Standard Z87.1, from American National Standards Institute, 11 West 42nd Street, New York, NY 10036-8002 (phone: 212-642-4900, website: [www.ansi.org](http://www.ansi.org)).

*Standard for Fire Prevention During Welding, Cutting, and Other Hot Work*, NFPA Standard 51B, from National Fire Protection Association, P.O. Box 9101, 1 Battery March Park, Quincy, MA 02269-9101 (phone: 617-770-3000, website: [www.nfpa.org](http://www.nfpa.org) and [www.sparky.org](http://www.sparky.org)).

OSHA, Occupational Safety and Health Standards for General Industry, Title 29, Code of Federal Regulations (CFR), Part 1910, Subpart Q, and Part 1926, Subpart J, from U.S. Government Printing Office, Superintendent of Documents, P.O. Box 371954, Pittsburgh, PA 15250 (there are 10 Regional Offices—phone for Region 5, Chicago, is 312-353-2220, website: [www.osha.gov](http://www.osha.gov)).

## 1-5. EMF Information

Considerations About Welding And The Effects Of Low Frequency Electric And Magnetic Fields

Welding current, as it flows through welding cables, will cause electromagnetic fields. There has been and still is some concern about such fields. However, after examining more than 500 studies spanning 17 years of research, a special blue ribbon committee of the National Research Council concluded that: "The body of evidence, in the committee's judgment, has not demonstrated that exposure to power-frequency electric and magnetic fields is a human-health hazard." However, studies are still going forth and evidence continues to be examined. Until the final conclusions of the research are reached, you may wish to minimize your exposure to electromagnetic fields when welding or cutting.

To reduce magnetic fields in the workplace, use the following procedures:

1. Keep cables close together by twisting or taping them.
2. Arrange cables to one side and away from the operator.
3. Do not coil or drape cables around your body.
4. Keep welding power source and cables as far away from operator as practical.
5. Connect work clamp to workpiece as close to the weld as possible.

### About Pacemakers:

Pacemaker wearers consult your doctor first. If cleared by your doctor, then following the above procedures is recommended.



# SECTION 1 – CONSIGNES DE SÉCURITÉ – À LIRE AVANT UTILISATION

som\_nd\_fre 7/02

## 1-1. Signification des symboles



Signifie « Mise en garde. Faire preuve de vigilance. » Cette procédure présente des risques identifiés par les symboles adjacents aux directives.

### ▲ Identifie un message de sécurité particulier.

Signifie « NOTA » ; n'est pas relatif à la sécurité.



Ce groupe de symboles signifie « Mise en garde. Faire preuve de vigilance. » Il y a des dangers liés aux CHOCS ÉLECTRIQUES, aux PIÈCES EN MOUVEMENT et aux PIÈCES CHAUDES. Se reporter aux symboles et aux directives ci-dessous afin de connaître les mesures à prendre pour éviter tout danger.

## 1-2. Dangers relatifs au soudage à l'arc

▲ Les symboles ci-après sont utilisés tout au long du présent manuel pour attirer l'attention sur les dangers potentiels et les identifier. Lorsqu'on voit un symbole, faire preuve de vigilance et suivre les directives mentionnées afin d'éviter tout danger. Les consignes de sécurité énoncées ci-après ne font que résumer le contenu des normes de sécurité mentionnées à la section 1-4. Lire et respecter toutes ces normes.

▲ L'installation, l'utilisation, l'entretien et les réparations ne doivent être confiés qu'à des personnes qualifiées.

▲ Pendant l'utilisation de l'appareil, tenir à l'écart toute personne, en particulier les enfants.



### LES DÉCHARGES ÉLECTRIQUES peuvent être mortelles.

Un simple contact avec des pièces sous tension peut causer une électrocution ou des blessures graves. L'électrode et le circuit de soudage sont sous tension dès que l'appareil est en fonctionnement. Le circuit d'entrée et les circuits internes de l'appareil sont également sous tension. En soudage semi-automatique ou automatique, le fil, le dévidoir, le logement des galets d'entraînement et les pièces métalliques en contact avec le fil de soudage sont sous tension. Tout matériel mal installé ou mal mis à la terre présente un danger.

- Ne jamais toucher aux pièces électriques sous tension.
- Porter des gants et des vêtements de protection secs et exempts de trous.
- S'isoler de la pièce et de la terre au moyen de tapis ou autres dispositifs isolants suffisamment grands pour empêcher tout contact physique avec la pièce ou la terre.
- Ne pas se servir d'une source de courant alternatif dans les zones humides, les endroits confinés ou là où on risque de tomber.
- Ne se servir d'une source de courant alternatif QUE si le procédé de soudage l'exige.
- Si l'utilisation d'une source de courant alternatif s'avère nécessaire, se servir de la fonction de télécommande si l'appareil en est équipé.
- Couper l'alimentation ou arrêter le moteur avant de procéder à l'installation, à la réparation ou à l'entretien de l'appareil. Couper/étiqueter l'alimentation selon la norme OSHA 29 CFR 1910.147 (voir les normes de sécurité).
- Installer et mettre à la terre correctement l'appareil conformément à son manuel d'utilisation et aux codes nationaux, provinciaux et municipaux.
- Toujours vérifier la terre du cordon d'alimentation – Vérifier et s'assurer que le fil de terre du cordon d'alimentation est bien raccordé à la borne de terre du sectionneur ou que la fiche du cordon est raccordée à une prise correctement mise à la terre.
- Pour exécuter les branchements d'entrée, fixer d'abord le conducteur de mise à la terre adéquat et contre-vérifier les connexions.
- Vérifier fréquemment le cordon d'alimentation et s'assurer qu'il n'est ni endommagé ni dénudé ; le remplacer immédiatement s'il est endommagé – tout câble dénudé peut causer une électrocution.
- Mettre l'appareil hors tension quand on ne l'utilise pas.
- Ne pas utiliser de câbles usés, endommagés, de calibre insuffisant ou mal épissés.
- Ne pas s'enrouler les câbles autour du corps.
- Si la pièce soudée doit être mise à la terre, le faire directement avec un câble distinct.
- Ne pas toucher l'électrode quand on est en contact avec la pièce, la terre ou une électrode d'une autre machine.

- N'utiliser que du matériel en bon état. Réparer ou remplacer sur-le-champ les pièces endommagées. Entretien l'appareil conformément au présent manuel.
- Porter un harnais de sécurité quand on travaille en hauteur.
- Maintenir solidement en place tous les panneaux et capots.
- Fixer le câble de retour de façon à obtenir un bon contact métal sur métal avec la pièce à souder ou la table de travail, le plus près possible de la soudure.
- Ne pas connecter plus d'une électrode ou plus d'un câble de masse à un même terminal de sortie.

### Il subsiste un COURANT CONTINU IMPORTANT dans les convertisseurs après la suppression de l'alimentation électrique.

- Arrêter les convertisseurs, débrancher le courant électrique et décharger les condensateurs d'alimentation selon les instructions énoncées à la section Entretien avant de toucher les pièces.

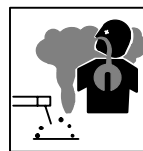

### LES FUMÉES ET LES GAZ peuvent être dangereux.

Le soudage génère des fumées et des gaz dont l'inhalation peut être dangereuse pour la santé.

- Se tenir à distance des fumées et ne pas les inhaler.
- À l'intérieur, ventiler la zone et/ou utiliser un dispositif d'aspiration au niveau de l'arc pour l'évacuation des fumées et des gaz de soudage.
- Si la ventilation est insuffisante, utiliser un respirateur à adduction d'air agréé.
- Lire les fiches techniques de santé-sécurité (FTSS) et les instructions du fabricant concernant les métaux, les consommables, les revêtements, les nettoyeurs et les dégraissateurs.
- Ne travailler dans un espace clos que s'il est bien ventilé ou porter un respirateur à adduction d'air. Demander toujours à un surveillant dûment formé de se tenir à proximité. Des fumées et des gaz de soudage peuvent se substituer à l'air, abaisser la teneur en oxygène et causer des lésions ou des accidents mortels. S'assurer que l'air est respirable.
- Ne pas souder à proximité d'opérations de dégraissage, de nettoyage ou de pulvérisation. La chaleur et les rayons de l'arc peuvent réagir en présence de vapeurs et former des gaz hautement toxiques et irritants.
- Ne pas souder de métaux munis d'un revêtement, tels que la tôle d'acier galvanisée, plombée ou cadmiée, à moins que le revêtement n'ait été enlevé dans la zone de soudage, que l'endroit soit bien ventilé, et si nécessaire, porter un respirateur à adduction d'air. Les revêtements et tous les métaux renfermant ces éléments peuvent dégager des fumées toxiques lorsqu'on les soude.



### LES RAYONS DE L'ARC peuvent causer des brûlures oculaires et cutanées.

Le rayonnement de l'arc génère des rayons visibles et invisibles intenses (ultraviolets et infrarouges) susceptibles de causer des brûlures oculaires et cutanées. Des étincelles sont projetées pendant le soudage.

- Porter un masque de soudage muni d'un filtre de la nuance adéquate pour se protéger le visage et les yeux pendant le soudage ou pour regarder (voir les normes de sécurité ANSI Z49.1 et Z87.1).
- Porter des lunettes de sécurité à écrans latéraux sous le masque.
- Utiliser des écrans ou des barrières pour protéger les tiers de l'éclat éblouissant ou aveuglant de l'arc ; leur demander de ne pas regarder l'arc.
- Porter des vêtements de protection en matière durable et ignifuge (cuir ou laine) et des chaussures de sécurité.



### LE SOUDAGE peut causer un incendie ou une explosion.

Le soudage effectué sur des récipients fermés tels que des réservoirs, des fûts ou des conduites peut causer leur éclatement. Des étincelles peuvent être projetées de l'arc de soudure. La projection d'étincelles, les pièces chaudes et les équipements chauds peuvent causer des incendies et des brûlures. Le contact accidentel de l'électrode avec tout objet métallique peut causer des étincelles, une explosion, un surchauffement ou un incendie. Avant de commencer le soudage, vérifier et s'assurer que l'endroit ne présente pas de danger.

- Se protéger et protéger les tiers de la projection d'étincelles et de métal chaud.
- Ne pas souder à un endroit où des étincelles peuvent tomber sur des substances inflammables.
- Placer toutes les substances inflammables à une distance de 10,7 m de l'arc de soudage. En cas d'impossibilité, les recouvrir soigneusement avec des protections agréées.
- Des étincelles et des matières en fusion peuvent facilement passer même par des fissures et des ouvertures de petites dimensions.
- Surveiller tout déclenchement d'incendie et tenir un extincteur à proximité.
- Le soudage effectué sur un plafond, un plancher, une paroi ou une cloison peut déclencher un incendie de l'autre côté.
- Ne pas souder des récipients fermés tels que des réservoirs, des fûts ou des conduites, à moins qu'ils n'aient été préparés conformément à l'AWS F4.1 (voir les normes de sécurité).
- Brancher le câble sur la pièce le plus près possible de la zone de soudage pour éviter que le courant ne circule sur une longue distance, par des chemins inconnus, et ne cause des risques d'électrocution et d'incendie.
- Ne pas utiliser le poste de soudage pour dégeler des conduites gelées.
- En cas de non utilisation, enlever la baguette d'électrode du porte-électrode ou couper le fil au raz du tube-contact.
- Porter des vêtements de protection exempts d'huile tels que des gants en cuir, une chemise en tissu épais, des pantalons sans revers, des chaussures montantes et un masque.
- Avant de souder, retirer tout produit combustible de ses poches, tel qu'un briquet au butane ou des allumettes.

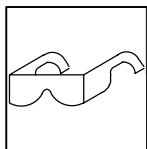

### LES PARTICULES PROJETÉES peuvent blesser les yeux.

- Le soudage, le burinage, le passage de la pièce à la brosse métallique et le meulage provoquent l'émission d'étincelles et de particules métalliques. Pendant leur refroidissement, les soudures risquent de projeter du laitier.
  - Porter des lunettes de sécurité à écrans latéraux agréés, même sous le masque de soudage.



### LES ACCUMULATIONS DE GAZ peuvent causer des blessures ou même la mort.

- Couper l'alimentation en gaz protecteur en cas de non utilisation.
- Veiller toujours à bien ventiler les espaces confinés ou porter un respirateur à adduction d'air agréé.



### LES PIÈCES CHAUDES peuvent causer des brûlures graves.

- Ne pas toucher les pièces chaudes à main nue.
- Prévoir une période de refroidissement avant d'utiliser le pistolet ou la torche.

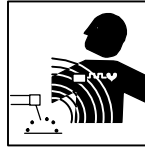

### LES CHAMPS MAGNÉTIQUES peuvent perturber le fonctionnement des stimulateurs cardiaques.

- Les personnes qui portent un stimulateur cardiaque doivent se tenir à distance.
- Ils doivent consulter leur médecin avant de s'approcher d'un lieu où on exécute des opérations de soudage à l'arc, de gougeage ou de soudage par points.

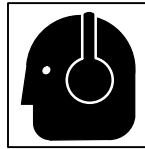

### LE BRUIT peut affecter l'ouïe.

Le bruit de certains processus et équipements peut affecter l'ouïe.

- Porter des protecteurs d'oreille agréés si le niveau sonore est trop élevé.

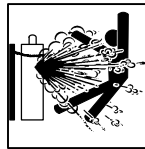

### Les BOUTEILLES endommagées peuvent exploser.

Les bouteilles de gaz protecteur contiennent du gaz sous haute pression. Toute bouteille endommagée peut exploser. Comme les bouteilles de gaz font normalement partie du procédé de soudage, les manipuler avec précaution.

- Protéger les bouteilles de gaz comprimé de la chaleur excessive, des chocs mécaniques, du laitier, des flammes nues, des étincelles et des arcs.
- Placer les bouteilles debout en les fixant dans un support stationnaire ou dans un porte-bouteilles pour les empêcher de tomber ou de se renverser.
- Tenir les bouteilles éloignées des circuits de soudage ou autres circuits électriques.
- Ne jamais poser une torche de soudage sur une bouteille de gaz.
- Ne jamais mettre une électrode de soudage en contact avec une bouteille de gaz.
- Ne jamais souder une bouteille contenant du gaz sous pression – elle risquerait d'exploser.
- N'utiliser que les bouteilles de gaz protecteur, régulateurs, tuyaux et raccords adéquats pour l'application envisagée ; les maintenir en bon état, ainsi que les pièces connexes.
- Détourner la tête lorsqu'on ouvre la soupape d'une bouteille.
- Laisser le capuchon protecteur sur la soupape, sauf en cas d'utilisation ou de branchement de la bouteille
- Lire et suivre les instructions concernant les bouteilles de gaz comprimé, les équipements associés et les publications P-1 de la CGA, mentionnées dans les normes de sécurité.

### 1-3. Autres symboles relatifs à l'installation, au fonctionnement et à l'entretien de l'appareil.



#### Risque D'INCENDIE OU D'EXPLOSION

- Ne pas placer l'appareil sur une surface inflammable, ni au-dessus ou à proximité d'elle.
- Ne pas installer l'appareil à proximité de produits inflammables.
- Ne pas surcharger l'installation électrique – s'assurer que l'alimentation est correctement dimensionnée et protégée avant de mettre l'appareil en service.



#### LA CHUTE DE L'APPAREIL peut blesser.

- N'utiliser que l'anneau de levage pour lever l'appareil. NE PAS utiliser le chariot, les bouteilles de gaz ou tout autre accessoire.
- Utiliser un engin de capacité adéquate pour lever l'appareil.
- Si on utilise un chariot élévateur pour déplacer l'unité, s'assurer que les fourches sont suffisamment longues pour dépasser du côté opposé de l'appareil.

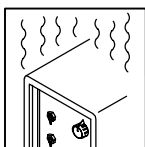

#### L'EMPLOI EXCESSIF peut FAIRE SURCHAUFFER L'ÉQUIPEMENT.

- Prévoir une période de refroidissement ; respecter le cycle opératoire nominal.
- Réduire le courant ou le cycle opératoire avant de reprendre le soudage.
- Ne pas obstruer les orifices ou filtrer l'alimentation en air du poste.

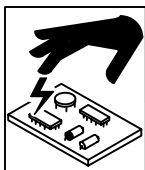

#### LES CHARGES ÉLECTROSTATIQUES peuvent endommager les circuits imprimés.

- Mettre un bracelet antistatique AVANT de manipuler des cartes ou des pièces.
- Utiliser des pochettes et des boîtes antistatiques pour stocker, déplacer ou expédier des cartes de circuits imprimés.

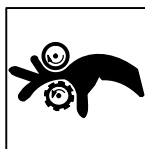

#### LES PIÈCES MOBILES peuvent causer des blessures.

- Se tenir à l'écart des pièces mobiles.
- Se tenir à l'écart des points de coincement tels que les dévidoirs.



#### LES FILS DE SOUDAGE peuvent causer des blessures.

- Ne pas appuyer sur la gâchette avant d'en avoir reçu l'instruction.
- Ne pas diriger le pistolet vers soi, vers d'autres personnes ou vers toute pièce mécanique en engageant le fil de soudage.



#### LES ORGANES MOBILES peuvent causer des blessures.

- Se tenir à l'écart des organes mobiles comme les ventilateurs.
- Maintenir fermés et bien fixés les portes, panneaux, recouvrements et dispositifs de protection.

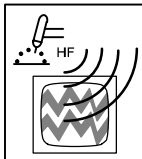

#### LE RAYONNEMENT HAUTE FRÉQUENCE (H. F.) risque de causer des interférences.

- Le rayonnement haute fréquence peut causer des interférences avec les équipements de radio-navigation et de communication, les services de sécurité et les ordinateurs.
- Ne demander qu'à des personnes qualifiées familiarisées avec les équipements électroniques de faire fonctionner l'installation.
- L'utilisateur est tenu de faire corriger rapidement par un électricien qualifié les interférences causées par l'installation.
- Si la Federal Communications Commission signale des interférences, arrêter immédiatement l'appareil.
- Faire régulièrement contrôler et entretenir l'installation.
- Maintenir soigneusement fermés les panneaux et les portes des sources de haute fréquence, maintenir le jeu d'éclatement au réglage adéquat et utiliser une terre et un blindage pour réduire les interférences éventuelles.

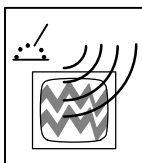

#### LE SOUDAGE À L'ARC peut causer des interférences.

- L'énergie électromagnétique peut causer des interférences avec l'équipement électronique sensible tel que les ordinateurs et l'équipement commandé par ordinateur tel que les robots.
- Veiller à ce que tout l'équipement de la zone de soudage soit compatible au point de vue électromagnétique.
- Pour réduire la possibilité d'interférence, maintenir les câbles de soudage aussi courts que possible, les grouper, et les poser aussi bas que possible (par ex. : à terre).
- Veiller à souder à une distance de 100 mètres de tout équipement électronique sensible.
- Veiller à ce que le poste de soudage soit posé et mis à la terre conformément au présent manuel.
- En cas d'interférences après exécution des directives précédentes, il incombe à l'utilisateur de prendre des mesures supplémentaires telles que le déplacement du poste, l'utilisation de câbles blindés, l'utilisation de filtres de ligne ou la pose de protecteurs dans la zone de travail.



#### LES CHAMPS MAGNÉTIQUES peuvent affecter les stimulateurs cardiaques.

- Porteurs de stimulateur cardiaque, restez à distance.
- Les porteurs d'un stimulateur cardiaque doivent d'abord consulter leur médecin avant de s'approcher des opérations de soudage à l'arc, de gougeage ou de soudage par points.

## 1-4. Principales normes de sécurité

Safety in Welding, Cutting, and Allied Processes, norme ANSI Z49.1, de l'American Welding Society, 550 N.W. LeJeune Rd, Miami FL 33126 (téléphone : (305) 443-9353, site Web : [www.aws.org](http://www.aws.org)).

Recommended Safe Practices for the Preparation for Welding and Cutting of Containers and Piping, norme American Welding Society AWS F4.1, de l'American Welding Society, 550 N.W. LeJeune Rd, Miami, FL 33126 (téléphone : (305) 443-9353, site Web : [www.aws.org](http://www.aws.org)).

National Electrical Code, norme NFPA 70, de la National Fire Protection Association, P.O. Box 9101, 1 Battery March Park, Quincy, MA 02269-9101 (téléphone : (617) 770-3000, sites Web : [www.nfpa.org](http://www.nfpa.org) et [www.sparky.org](http://www.sparky.org)).

Safe Handling of Compressed Gases in Cylinders, brochure CGA P-1, de la Compressed Gas Association, 1735 Jefferson Davis Highway, Suite 1004, Arlington, VA 22202-4102 (téléphone : (703) 412-0900, site Web : [www.cganet.com](http://www.cganet.com)).

Code for Safety in Welding and Cutting, norme CSA W117.2, de la Canadian Standards Association, Standards Sales, 178 boulevard

Rexdale, Rexdale (Ontario) Canada M9W 1R3 (téléphone : (800) 463-6727 ou à Toronto : (416) 747-4044, site Web : [www.csa-international.org](http://www.csa-international.org)).

Practice For Occupational And Educational Eye And Face Protection, norme ANSI Z87.1, de l'American National Standards Institute, 11 West 42nd Street, New York, NY 10036-8002 (téléphone : (212) 642-4900, site Web : [www.ansi.org](http://www.ansi.org)).

Standard for Fire Prevention During Welding, Cutting, and Other Hot Work, norme NFPA 51B, de la National Fire Protection Association, P.O. Box 9101, 1 Battery March Park, Quincy, MA 02269-9101 (téléphone : (617) 770-3000, site Web : [www.nfpa.org](http://www.nfpa.org) et [www.sparky.org](http://www.sparky.org)).

OSHA, Occupational Safety and Health Standards for General Industry, Title 29, Code of Federal Regulations (CFR), Part 1910, Subpart Q, and Part 1926, Subpart J, de l'U.S. Government Printing Office, Superintendent of Documents, P.O. Box 371954, Pittsburgh, PA 15250 (il y a 10 bureaux régionaux – Téléphone pour la Région 5, Chicago : (312) 353-2220, site Web : [www.osha.gov](http://www.osha.gov)).

## 1-5. Information sur les champs électromagnétiques

Données sur le soudage électrique et les effets des champs magnétiques basse fréquence sur l'organisme

En parcourant les câbles de soudage, le courant crée des champs électromagnétiques. Les effets potentiels de tels champs restent préoccupants. Cependant, après avoir examiné plus de 500 études qui ont été faites pendant une période de recherche de 17 ans, un comité de spécialistes du National Research Council a conclu : « L'accumulation de preuves n'a pas démontré que l'exposition aux champs magnétiques et aux champs électriques à haute fréquence constitue un risque pour la santé humaine ». Toutefois, les études et l'examen des preuves se poursuivent. En attendant les conclusions finales de la recherche, il serait souhaitable de réduire l'exposition aux champs électromagnétiques pendant le soudage ou le coupage.

Afin de réduire les champs électromagnétiques en milieu de travail, respecter les consignes suivantes :

1. Garder les câbles ensemble en les torsadant ou en les fixant avec du ruban adhésif.
2. Mettre tous les câbles du côté opposé à l'opérateur.
3. Ne pas s'enrouler les câbles autour du corps.
4. Garder le poste de soudage et les câbles le plus loin possible de soi.
5. Placer la pince de masse le plus près possible de la zone de soudage.

### Consignes relatives aux stimulateurs cardiaques :

Les personnes qui portent un stimulateur cardiaque doivent avant tout consulter leur médecin. Si ce dernier les déclare aptes, il leur est recommandé de respecter les consignes ci-dessus.

# SECTION 2 – DEFINITIONS

## 2-1. Warning Label Definitions

Warning! Watch Out! There are possible hazards as shown by the symbols.

- 1 Electric shock from welding electrode or wiring can kill.
- 1.1 Wear dry insulating gloves. Do not touch electrode with bare hand. Do not wear wet or damaged gloves.
- 1.2 Protect yourself from electric shock by insulating yourself from work and ground.
- 1.3 Disconnect input plug or power before working on machine.

- 2 Breathing welding fumes can be hazardous to your health.
- 2.1 Keep your head out of the fumes.
- 2.2 Use forced ventilation or local exhaust to remove the fumes.
- 2.3 Use ventilating fan to remove fumes.
- 3 Welding sparks can cause explosion or fire.
- 3.1 Keep flammables away from welding. Do not weld near flammables.
- 3.2 Welding sparks can cause fires. Have a fire extinguisher nearby, and have a watchperson ready to use it.
- 3.3 Do not weld on drums or any closed containers.

- 4 Arc rays can burn eyes and injure skin.
- 4.1 Wear hat and safety glasses. Use ear protection and button shirt collar. Use welding helmet with correct shade of filter. Wear complete body protection.
- 5 Become trained and read the instructions before working on the machine or welding.
- 6 Do not remove or paint over (cover) the label.

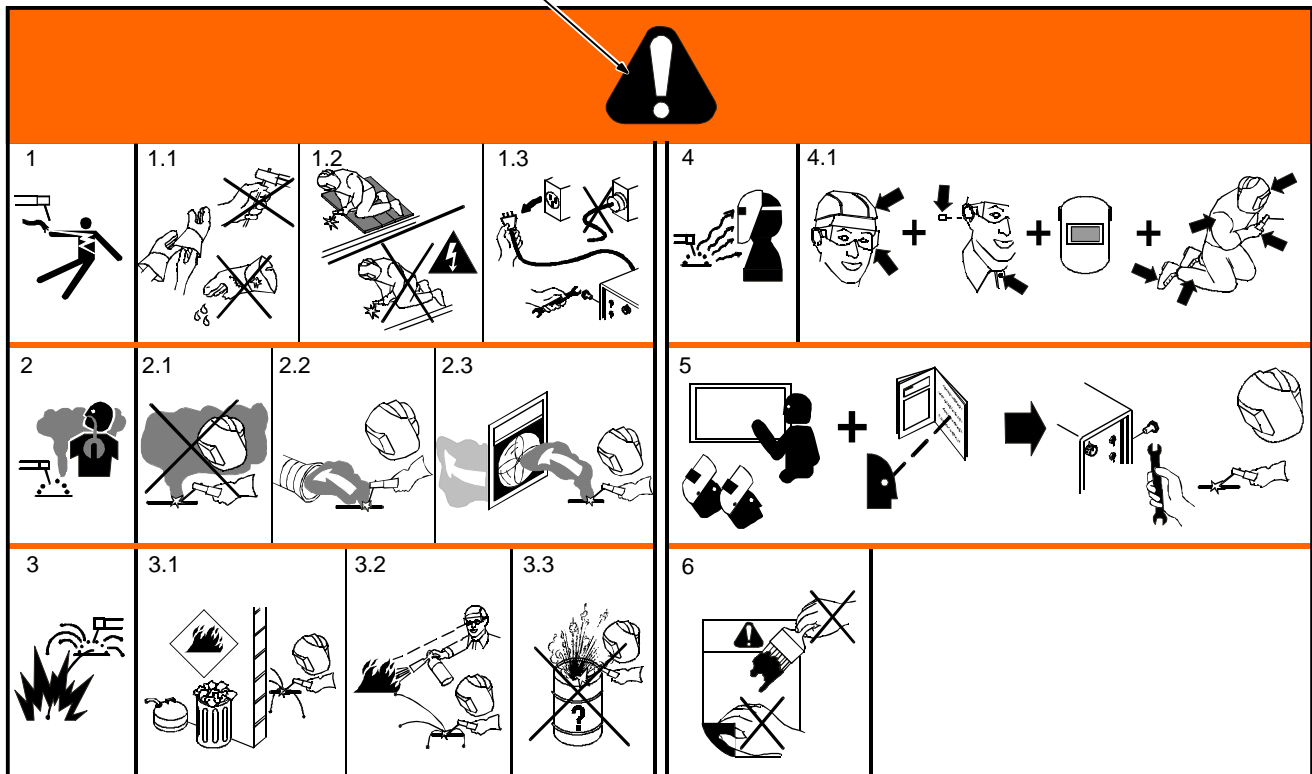

S-179 310 A

## 2-2. Torch/Cable Holder Label

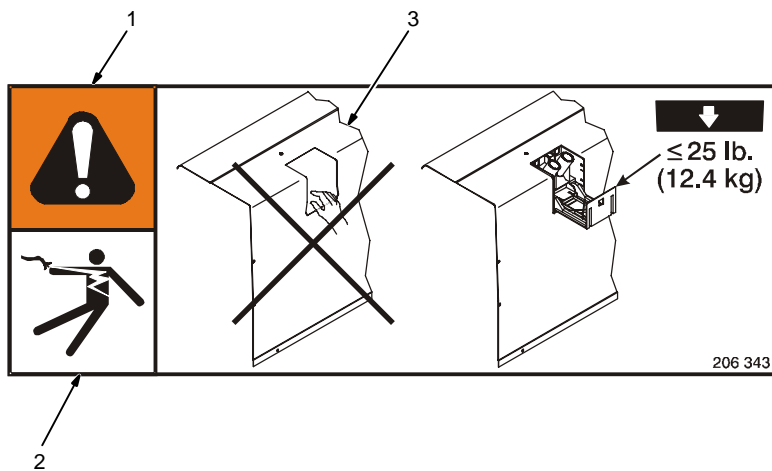





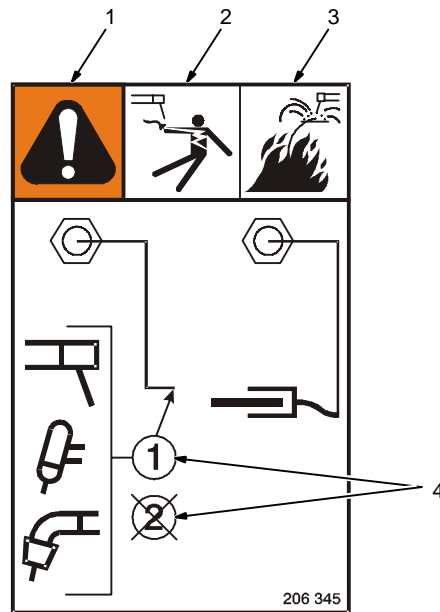

- 1 Warning! Watch Out! There are possible hazards as shown by the symbols.
- 2 Electric shock from wiring can kill.
- 3 Do not operate unit or reach inside when torch/cable holder is removed.
- 4 Do not exceed 25 lb (12.4 kg) maximum load on gun/cable holder or holder may break.

## 2-3. Weld Cable Connection Label



















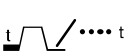











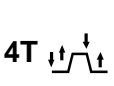





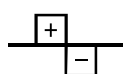







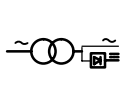

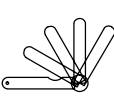
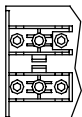

- 1 Warning! Watch Out! There are possible hazards as shown by the symbols.
- 2 Electric shock from welding electrode or wiring can kill.
- 3 Welding sparks or arcing from unused electrode can cause explosion or fire.
- 4 Do not connect more than one electrode cable to any single weld output terminal. Disconnect cables for process not in use. Have only one welding circuit (process) connected at any given time — never two.

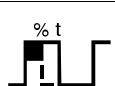
## 2-4. Manufacturer's Rating Label For CE Products

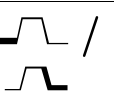
		ISO/IEC 60974-1			
		3A/10.2V		400A/26V	
		X	30%	60%	100%
	U <sub>0</sub> = 74V	I <sub>2</sub>	400A	300A	235A
		U <sub>2</sub>	26V	22V	19.4V
		3A/10.2V		400A/36V	
		X	30%	60%	100%
	U <sub>0</sub> = 74V	I <sub>2</sub>	400A	300A	235A
		U <sub>2</sub>	36V	32V	29.4V
 1~ 50 Hz	U <sub>1</sub> = 220	I <sub>1max</sub> = 154.58A	I <sub>1Eff</sub> = 70.89A		
	U <sub>1</sub> = 400	I <sub>1max</sub> = 83.4A	I <sub>1Eff</sub> = 38.2A		
	U <sub>1</sub> = 440	I <sub>1max</sub> = 75.49A	I <sub>1Eff</sub> = 34.62A		
	U <sub>1</sub> = 520	I <sub>1max</sub> = 64.24A	I <sub>1Eff</sub> = 29.46A		
IP23S					
190 523					

## 2-5. Symbols And Definitions

<b>NOTE</b> 	<i>Some symbols are found only on CE products.</i>
---	--

<b>A</b> Amperes	 Panel-Local	 Gas Tungsten Arc Welding (GTAW)	 Shielded Metal Arc Welding (SMAW)
<b>V</b> Volts	 Do Not Switch While Welding	 Arc Force (DIG)	 Spot Timer
 Output	 Circuit Breaker	 Remote	 Temperature
 Protective Earth (Ground)	 Alternating Current	 High Frequency - Start	 Input
 $t_2$ Postflow Timer	 $t_1$ Preflow Timer	 High Frequency - Continuous	 4T $\uparrow \downarrow \uparrow \downarrow$ 4 Step Trigger Operation Sequence
 Gas (Supply)	 Gas Input	 Gas Output	 Increase/Decrease Of Quantity
<b>I</b> On	 Off	<b>%</b> Percent	 Direct Current
 Balance Control	 Maximum Cleaning	 Maximum Penetration	 Electrode Positive
 Electrode Negative	 $t$ Crater Time	 Meter	 1 $\sim$ Single-Phase
<b>U<sub>0</sub></b> Rated No Load Voltage (Average)	<b>U<sub>1</sub></b> Primary Voltage	<b>U<sub>2</sub></b> Conventional Load Voltage	 Line Connection
<b>I<sub>1</sub></b> Primary Current	<b>I<sub>2</sub></b> Rated Welding Current	<b>X</b> Duty Cycle	 Single-Phase Combined AC/DC Power Source
<b>IP</b> Degree Of Protection	<b>I<sub>1eff</sub></b> Maximum Effective Supply Current	<b>I<sub>1max</sub></b> Rated Maximum Supply Current	<b>Hz</b> Hertz
 Electrode	 Work	 Thickness Gauge	 Spark Gap
<b>S</b> Seconds	 $A$ Final Current	 $t$ Start Time	 $A$ Start Amperage
 $\% t$ Peak Time	 Spot Sequence	 Start/Crater Sequence	 Start Sequence
 Crater Sequence	 Pulsar	 $A$ Background Amps	 $f$ Pulse Frequency



# SECTION 3 – INSTALLATION

## 3-1. Selecting A Location

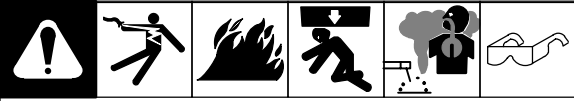

### Movement

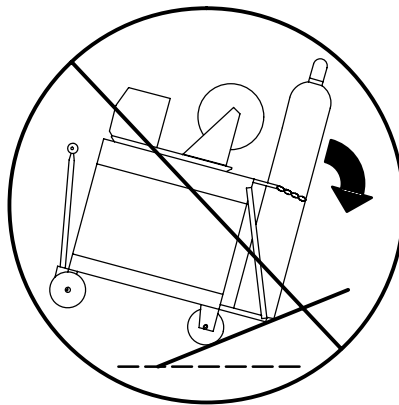
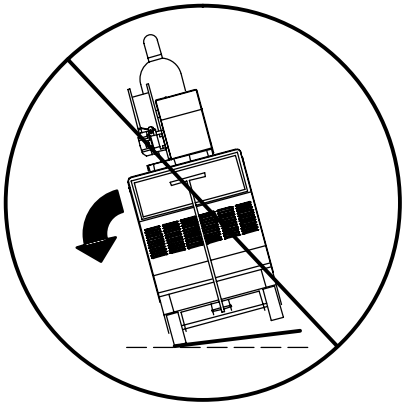
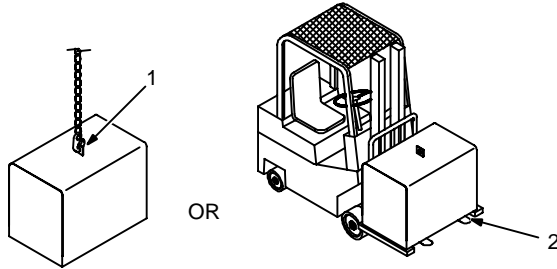

### ▲ Falling Unit Can Cause Injury.

- Use lifting eye to lift unit only, NOT running gear, gas cylinders, or any other accessories.
- Use equipment of adequate capacity to lift and support unit.
- If using lift forks to move unit, be sure forks are long enough to extend beyond opposite side of unit.

1 Lifting Eye

2 Lifting Forks

Use lifting eye or lifting forks to move unit.

If using lifting forks, extend forks beyond opposite side of unit.

3 Rating Label

Use rating label to determine input power needs.

4 Line Disconnect Device

Locate unit near correct input power supply.

▲ **Special installation may be required where gasoline or volatile liquids are present – see NEC Article 511 or CEC Section 20.**

▲ **Be careful when placing or moving unit over uneven surfaces.**

### Location And Airflow

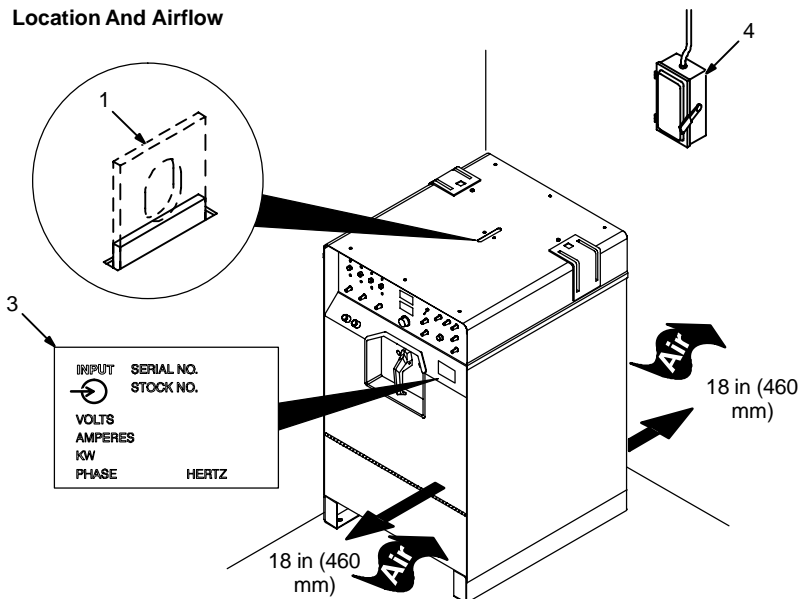

INPUT	SERIAL NO.
	STOCK NO.
VOLTS	
AMPERES	
KW	
PHASE	HERTZ

### 3-2. Dimensions And Weights



Dimensions	
Height	39-3/4 in (1010 mm) with retractable lifting eye down
Width	22-1/2 in (572 mm)
Length	25 in (635 mm)
A	25 in (635 mm)
B	23-5/8 in (600 mm)
C	1-3/8 in (35 mm)
D	7/8 in (22 mm)
E	19-15/16 (506 mm)
F	22-1/4 (565 mm)
G	1/2 in (13 mm) Dia
Weight	
526 lbs (239 kg)	

### 3-3. Specifications

Rated Welding Output	PFC **	Amperes Input at AC Balanced Rated Load Output, 50/60 Hz, Single-Phase								KVA	KW	Amperage Range	Max OCV
		200V	220V	230V	400V	440V	460V	520V	575V				
NEMA Class I (60) – 300 Amperes, 32 Volts AC, 60% Duty Cycle	No PFC	129 5*	117 5*	112 4*	65 3*	58 2*	56 2*	49 2*	45 2*	25.0 0.9*	14.3 0.4*	3 – 400A	80V
	With PFC	98 69*	89 63*	85 60*	49 35*	44 31*	43 30*	37 26*	34 24*	19.5 14.0*	14.0 0.4*		
NEMA Class II (40) – 350 Amperes, 34 Volts AC, 40% Duty Cycle	No PFC	150 5*	137 5*	131 4*	75 3*	68 2*	66 2*	57 2*	53 2*	29.1 0.9*	17.7 0.4*	3 – 400A	80V
	With PFC	118 69*	107 63*	103 60*	59 35*	53 31*	52 30*	45 26*	41 24*	23.7 14.0*	17.7 0.4*		

\*While idling  
\*\*Power Factor Correction

### 3-4. Duty Cycle And Overheating

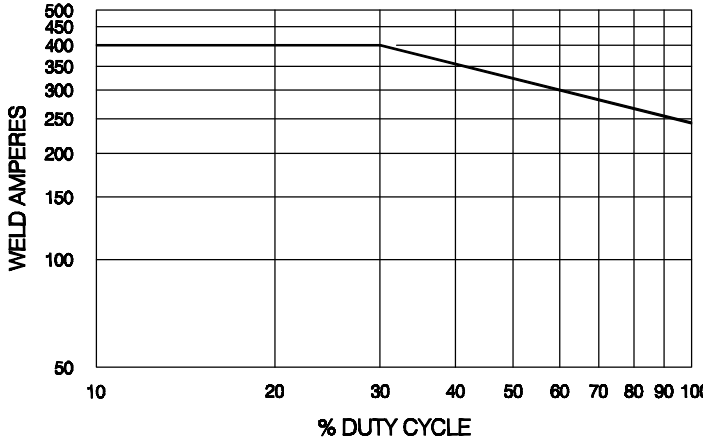

Duty Cycle is the percentage of 10 minutes that the unit can weld at rated load without overheating.

If unit overheats, output stops, front panel voltmeter/ammeter displays a HLP3 or HLP5 message (see Section 5-4), and cooling fans run. Wait fifteen minutes for unit to cool. Reduce amperage or duty cycle before welding.

**▲ Exceeding duty cycle can damage unit and void warranty.**

**40% Duty Cycle At 350 Amperes (60 Hz Models Only)**

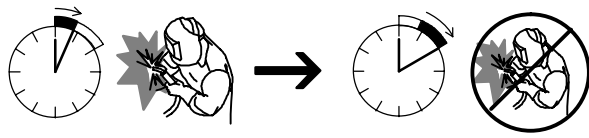

4 Minutes Welding      6 Minutes Resting

**60% Duty Cycle At 300 Amperes**

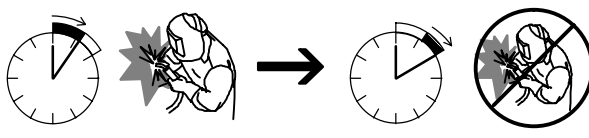

6 Minutes Welding      4 Minutes Resting

---

**Overheating**



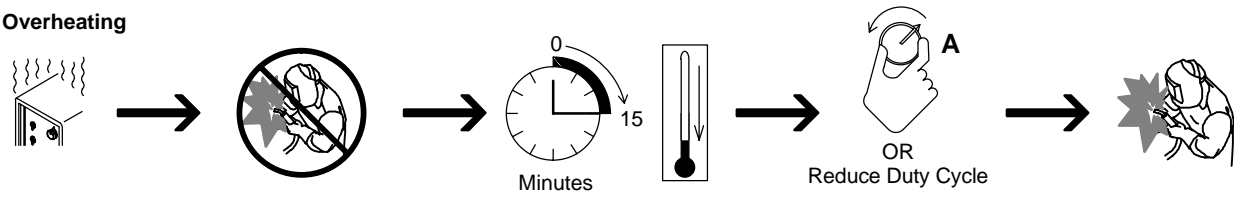

duty1 4/95 / SB-190 276

### 3-5. Volt-Ampere Curves

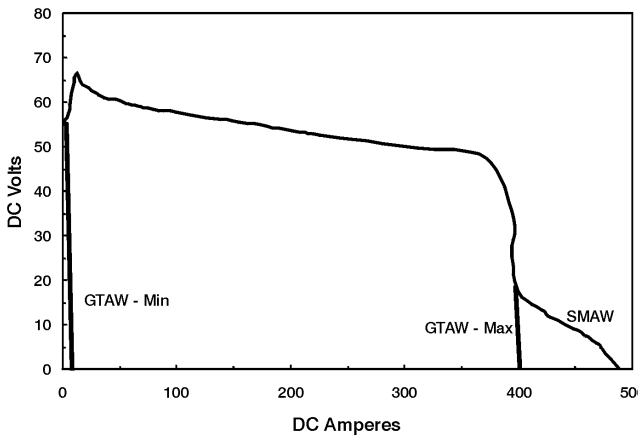

The volt-ampere curves show the minimum and maximum voltage and amperage output capabilities of the welding power source. Curves of other settings fall between the curves shown.

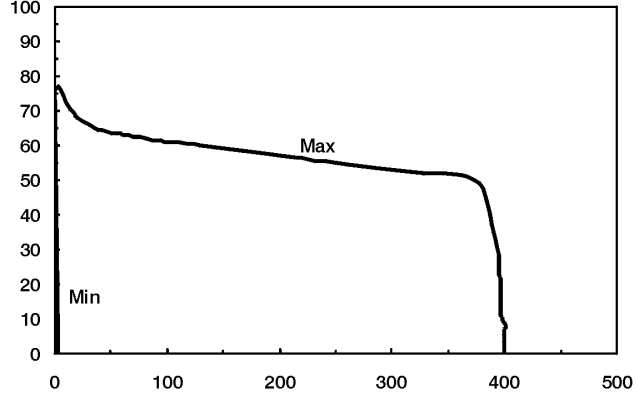

ssb1.1 10/91 - ST-

### 3-6. Weld Output Terminals And Selecting Cable Sizes



**▲ ARC WELDING can cause Electromagnetic Interference.**

To reduce possible interference, keep weld cables as short as possible, close together, and down low, such as on the floor. Locate welding operation 100 meters from any sensitive electronic equipment. Be sure this welding machine is installed and grounded according to this manual. If interference still occurs, the user must take extra measures such as moving the welding machine, using shielded cables, using line filters, or shielding the work area.



**▲ Turn off power before connecting to weld output terminals.**

**▲ Do not use worn, damaged, undersized, or poorly spliced cables.**

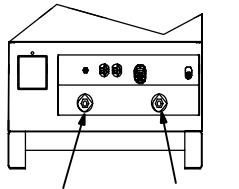

Work Electrode

Ref. ST-801 972-C

Welding Amperes	Total Cable (Copper) Length In Weld Circuit Not Exceeding							
	100 ft (30 m) Or Less	150 ft (45 m)	200 ft (60 m)	250 ft (70 m)	300 ft (90 m)	350 ft (105 m)	400 ft (120 m)	
	10 – 60% Duty Cycle	60 – 100% Duty Cycle	10 – 100% Duty Cycle					
100	4	4	4	3	2	1	1/0	1/0
150	3	3	2	1	1/0	2/0	3/0	3/0
200	3	2	1	1/0	2/0	3/0	4/0	4/0
250	2	1	1/0	2/0	3/0	4/0	2-2/0	2-2/0
300	1	1/0	2/0	3/0	4/0	2-2/0	2-3/0	2-3/0
350	1/0	2/0	3/0	4/0	2-2/0	2-3/0	2-3/0	2-4/0
400	1/0	2/0	3/0	4/0	2-2/0	2-3/0	2-4/0	2-4/0
500	2/0	3/0	4/0	2-2/0	2-3/0	2-4/0	3-3/0	3-3/0

Weld cable size (AWG) is based on either a 4 volts or less drop or a current density of at least 300 circular mils per ampere  
 \*Select weld cable size for pulsing application at peak amperage value..

S-0007-D

### 3-7. Remote 14 Receptacle



**▲ Turn off power before connecting to receptacle**

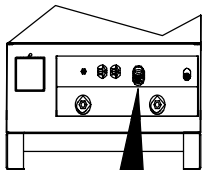

Ref. ST-801 972-C

	Socket*	Socket Information
	A	24 volts dc.
	B	Contact closure to A completes 24 volts dc contactor control circuit.
	C	Command reference; 0 to +10 volts dc output to remote control.
	D	Remote control/feedback circuit common.
	E	0 to +10 volts dc input command signal from remote control.
	K	Chassis common.
	F	Current feedback, 1 volt per 100 amperes.
	H	Voltage feedback, 1 volt per 10 arc volts.

\*The remaining sockets are not used.

### 3-8. Shielding Gas Connections And 115 Volts AC Duplex Receptacle

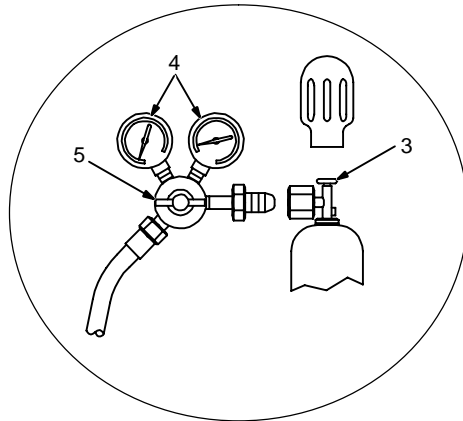

**▲ Turn Off power before making connections.**

1 Gas Valve In Fitting

Located on rear of unit.

2 Gas Valve Out Fitting

Fittings have 5/8-18 right-hand threads.

3 Cylinder Valve

Open valve slightly so gas flow blows dirt from valve. Close valve.

4 Regulator/Flow Gauge

Connect regulator/flow gauge to gas cylinder.

Connect customer supplied gas hose between regulator/flow gauge and gas in fitting.

5 Flow Adjust

Typical flow rate is 20 cfh (cubic feet per hour).

6 115 V AC Receptacle

Receptacle is protected from overload by circuit breaker CB1 (see Section 5-2).

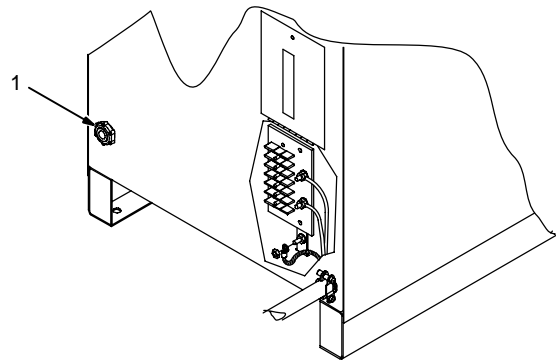
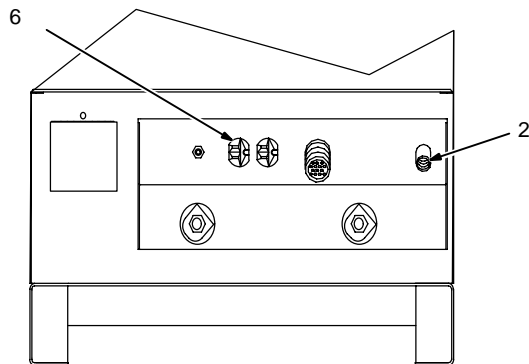

Tools Needed:

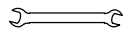
 5/8, 3/4, 1-1/8 in

Ref. ST-801 972-C / Ref. ST-801 973 / Ref. ST-157 858

### 3-9. Electrical Service Guide

## NOTE

All values calculated at 60% duty cycle.

50/60 Hertz Models	Without Power Factor Correction							
Input Voltage	200	220	230	400	440	460	520	575
Input Amperes At Rated Output	129	117	112	65	58	56	49	45
Max Recommended Standard Fuse Or Circuit Breaker Rating In Amperes	175	150	150	80	70	70	60	60
Min Input Conductor Size In AWG/Kcmil	4	4	4	8	8	8	8	10
Max Recommended Input Conductor Length In Feet (Meters)	111 (34)	134 (41)	146 (45)	196 (60)	238 (72)	260 (79)	332 (101)	273 (83)
Min Grounding Conductor Size In AWG/Kcmil	6	6	6	8	8	8	10	10
Reference: 1996 National Electrical Code (NEC)								S-0092-J

50/60 Hertz Models	With Power Factor Correction							
Input Voltage	200	220	230	400	440	460	520	575
Input Amperes At Rated Output	98	89	85	49	44	43	37	34
Max Recommended Standard Fuse Or Circuit Breaker Rating In Amperes	150	125	125	70	70	60	60	50
Min Input Conductor Size In AWG/Kcmil	4	4	4	8	8	8	10	10
Max Recommended Input Conductor Length In Feet (Meters)	117 (36)	141 (43)	154 (47)	204 (62)	246 (75)	269 (82)	230 (70)	281 (86)
Min Grounding Conductor Size In AWG/Kcmil	6	6	6	8	8	10	10	10
Reference: 1996 National Electrical Code (NEC)								S-0092-J

### 3-10. Placing Jumper Links

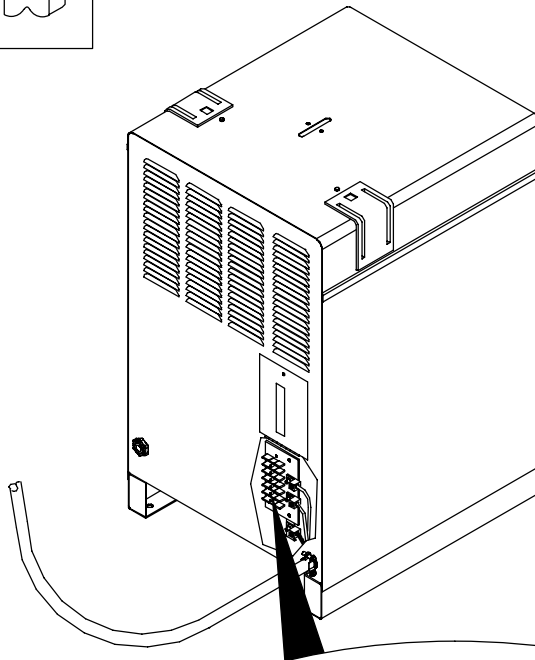

**▲ Disconnect and lockout/tag-out input power before installing or moving jumper links.**

Check input voltage available at site.

1 Jumper Link Label

Check label – only one is on unit.

2 Jumper Links

Move jumper links to match input voltage.

Close access door, or go on to Section 3-11.

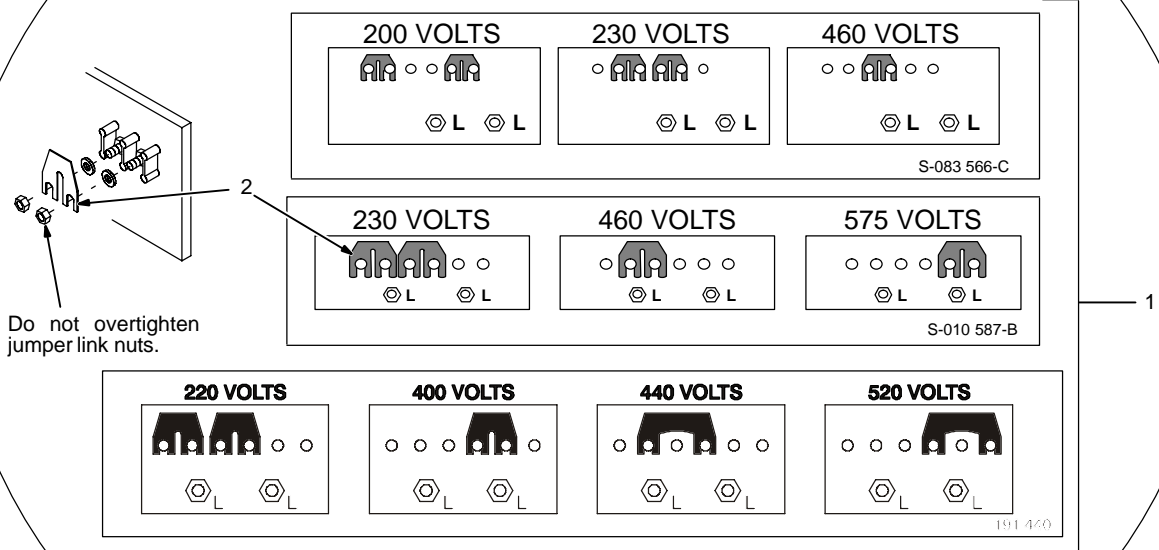

Tools Needed:

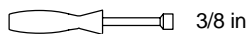

### 3-11. Connecting Input Power

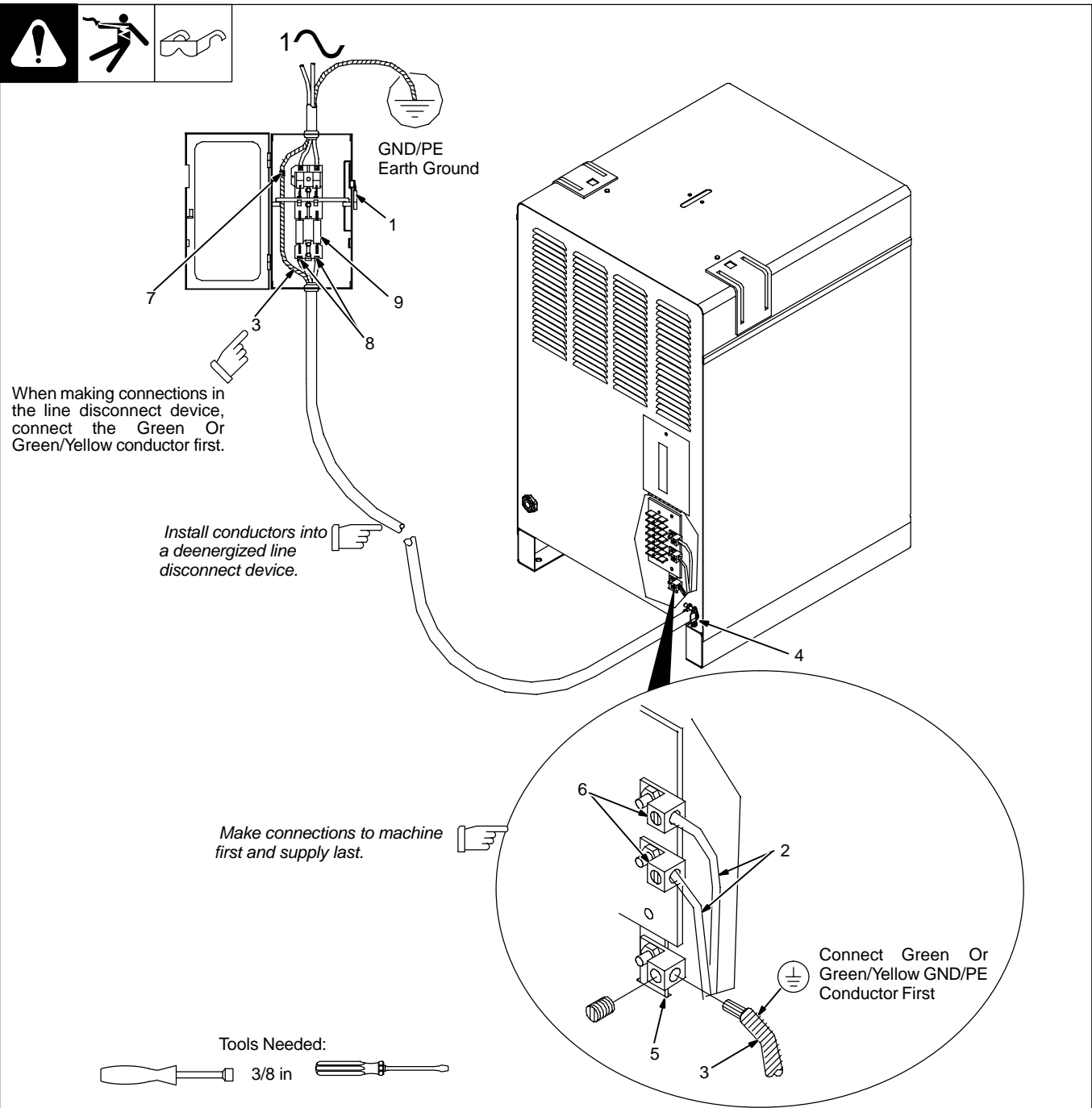

Ref. ST-801 973-B

▲ **Disconnect and lockout/tagout input power before connecting input conductors from unit.**

▲ **Have only qualified persons make this installation.**

See rating label on unit and check input voltage available at site.

- 1 Line Disconnect Device
- 2 Input Conductors
- 3 Grounding Conductor

Select size and length using Section 3-9. Conductors must comply with national, state, and local electrical codes. If applicable, use lugs of proper amperage capacity and correct hole size.

- 4 Strain Relief  
Route conductors through strain relief.
- 5 Machine Grounding Terminal
- 6 Line Terminals

▲ **Make input power connections to the welding power source before making connections into a deenergized line disconnect device.**

Connect green or green/yellow grounding conductor to machine grounding terminal first. Then connect input conductors to line terminals.

- Close access door.
- 7 Disconnect Device (Supply) Grounding Terminal
- 8 Disconnect Device Line Terminals

▲ **In the deenergized line disconnect device, connect green or green/yellow grounding conductor to supply grounding terminal first, never to a line terminal. Be sure grounding conductor goes to an earth ground.**

Connect input conductors to line terminals.  
9 Overcurrent Protection  
Select type and size using Section 3-9 (fused disconnect switch shown).  
Close door on line disconnect device.





## B. For CE Units

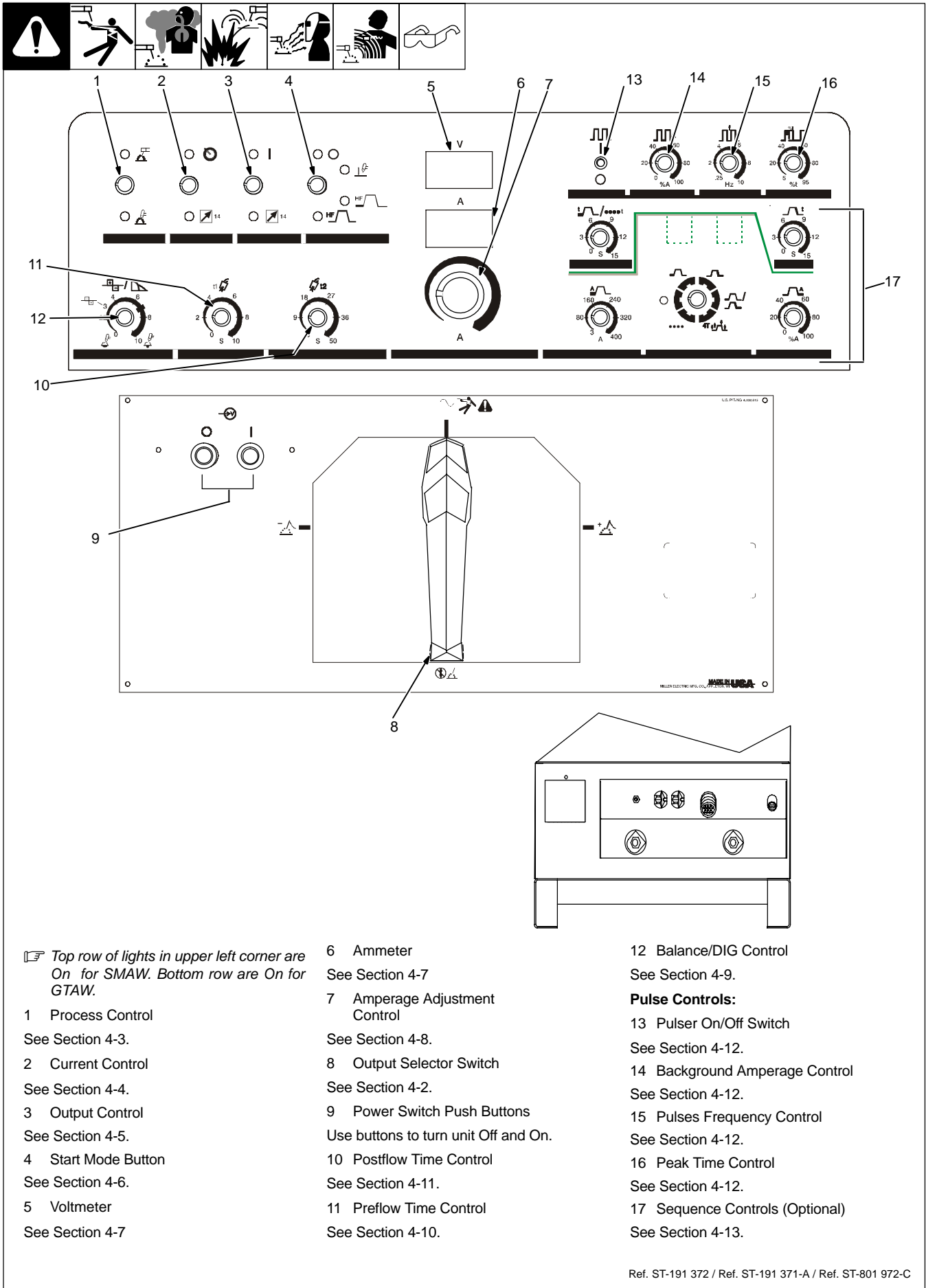

☐ Top row of lights in upper left corner are On for SMAW. Bottom row are On for GTAW.

- 1 Process Control  
See Section 4-3.
- 2 Current Control  
See Section 4-4.
- 3 Output Control  
See Section 4-5.
- 4 Start Mode Button  
See Section 4-6.
- 5 Voltmeter  
See Section 4-7

- 6 Ammeter  
See Section 4-7
- 7 Amperage Adjustment Control  
See Section 4-8.
- 8 Output Selector Switch  
See Section 4-2.
- 9 Power Switch Push Buttons  
Use buttons to turn unit Off and On.
- 10 Postflow Time Control  
See Section 4-11.
- 11 Preflow Time Control  
See Section 4-10.

- 12 Balance/DIG Control  
See Section 4-9.
- Pulse Controls:**
- 13 Pulser On/Off Switch  
See Section 4-12.
  - 14 Background Amperage Control  
See Section 4-12.
  - 15 Pulses Frequency Control  
See Section 4-12.
  - 16 Peak Time Control  
See Section 4-12.
  - 17 Sequence Controls (Optional)  
See Section 4-13.

## 4-2. Output Selector Switch

(CE Nameplate Shown)

1 Output Selector Switch

▲ Do not use AC output in damp areas, if movement is confined, or if there is danger of falling. Use AC output ONLY if required for the welding process, and then use a remote control.

▲ Do not change position of switch while welding or while under load.

Use switch to select (DCEN) Direct Current Electrode Negative, AC, or (DCEP) Direct Current Electrode Positive output without changing weld output cable connections.

**NOTE:** Changing position of Output Selector switch may also change Process control, Current control, Output control, and Start Mode control settings to properly function with latest Output Selector switch setting.

Ref. ST-191 372

## 4-3. Process Control

(CE Nameplate Only)

1 Process Control

Use control to select Shielded Metal Arc Welding (SMAW) or Gas Tungsten Arc Welding (GTAW) process.

For SMAW, press button to toggle LED to Stick position.

For GTAW, press button to toggle LED to TIG position.

**NOTE:** Lit LED indicates selected mode.

When Output Selector switch position changes, LED may change position, based upon last selection.

Ref. ST-191 372

## 4-4. Current Control

(CE Nameplate Only)

**1** Current Control

Use control to select front panel or remote current control.

For front panel current control, press button to toggle LED to Panel position.

For remote current control, press button to toggle LED to Remote 14 position (see Section 3-7).

**NOTE:** Lit LED indicates selected mode.

When Output Selector switch (see Section 4-2) position changes, LED may change position, based upon last selection.

## 4-5. Output Control

(CE Nameplate Only)

**1** Output Control

**▲ Weld output terminals are energized when power is On, and Output On LED is lit.**

Use control to select front panel or remote output control.

For weld output, press button to toggle LED to On position.

For remote output control, press button to toggle LED to Remote 14 position (see Section 3-7).

**NOTE:** Lit LED indicates selected mode.

When Output Selector switch (see Section 4-2) position changes, Output control LED will always change to Remote.

When Output On is selected, HF and gas control are disabled.

## 4-6. Start Mode

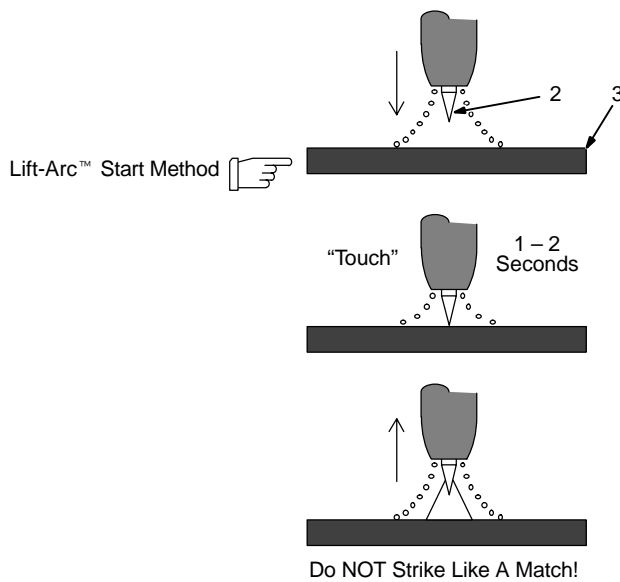
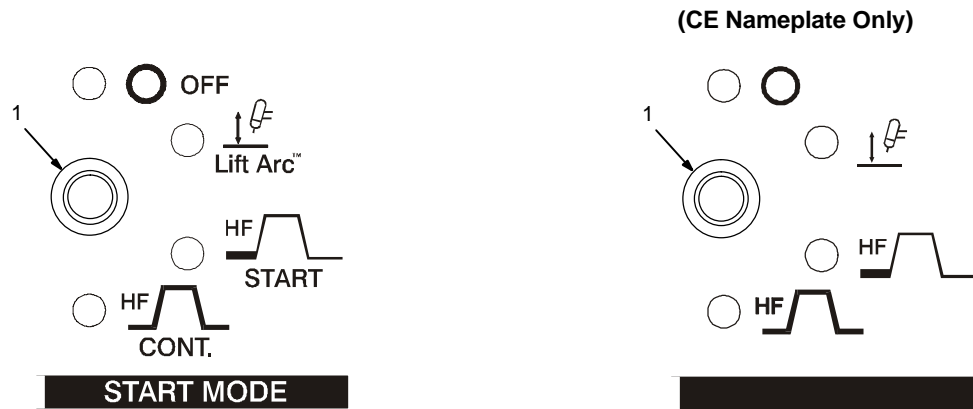

### 1 Start Mode

For SMAW welding, press button to toggle LED to Off position.

For GTAW welding, use control to select Off for no HF, Lift-Arc™, HF for arc starting only, or continuous HF.

#### Application:

When Off is selected, use the scratch method to start an arc for both the SMAW and GTAW processes.

**When Lift-Arc is selected, start arc as follows:**

### 2 TIG Electrode

### 3 Workpiece

Touch tungsten electrode to workpiece at weld start point, enable output with torch trigger, foot control, or hand control. **Hold electrode to workpiece for 1-2 seconds,**

and slowly lift electrode. An arc will form when electrode is lifted.

Shielding gas begins to flow when electrode touches work piece.

Normal open-circuit voltage is not present before tungsten electrode touches workpiece; only a low sensing voltage is present between electrode and workpiece. The solid state output contactor does not energize until after electrode is touching workpiece. This allows electrode to touch workpiece without overheating, sticking, or getting contaminated.

#### Application:

Lift-Arc is used for the DCEN GTAW process when HF Start method is not permitted.

**When HF Start is selected, start arc as follows:**

High frequency turns on to help start arc when output is enabled. High frequency

turns off when arc is started, and turns on whenever arc is broken to help restart arc.

#### Application:

HF Start is used when the DCEN GTAW process is required.

**When HF Continuous is selected, start arc as follows:**

High frequency turns on when output is energized and remains on for duration of weld.

#### Application:

HF Continuous is used when the AC GTAW process is required.

**NOTE:** Lit LED indicates selected mode.

When Output Selector switch position changes, LED may change position, based upon last selection.

**NOTE:** Some start methods may not be available for all processes.

## 4-7. Meters

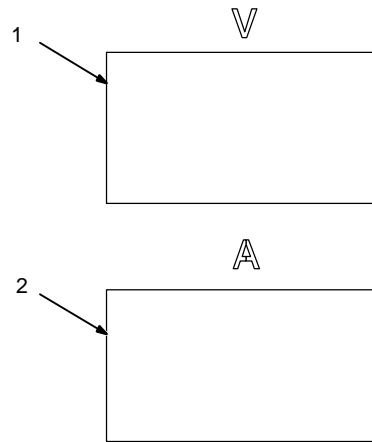

### 1 Voltmeter

Voltmeter displays average voltage (to the nearest 0.1 V) at the weld output terminals.

### 2 Ammeter

Use meter to preset amperage. Meter displays average weld amperage output of unit to nearest ampere when welding.

## 4-8. Amperage Adjustment Control

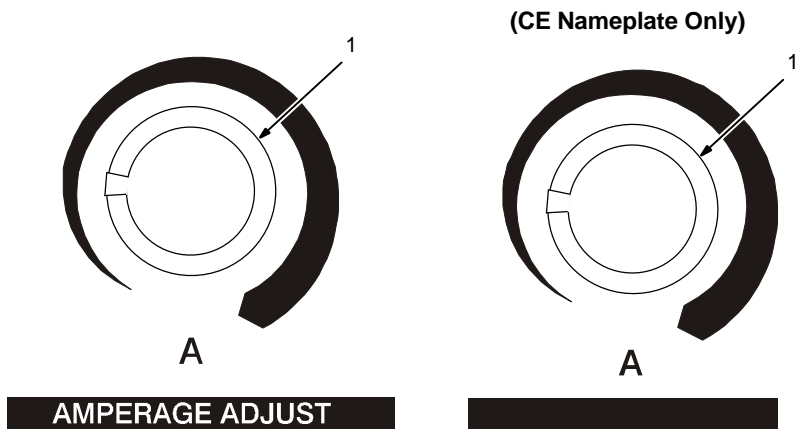

### 1 Amperage Adjustment Control

Use control to adjust amperage, and preset amperage on ammeter (see Section 4-7). This control may be adjusted while welding.

**For remote amperage control,** front panel control setting is the maximum amperage available. For example: If front panel control is set to 200 A, the range of the remote amperage control is 3 to 200 A.

**For pulse welding,** use Amperage Adjust control to select from 3–400 amps of peak amperage (see Section 4-12).

**For spot welding,** use Amperage Adjust control to select from 3–400 amps of peak amperage (see Section 4-14).

## 4-9. Balance/DIG Control

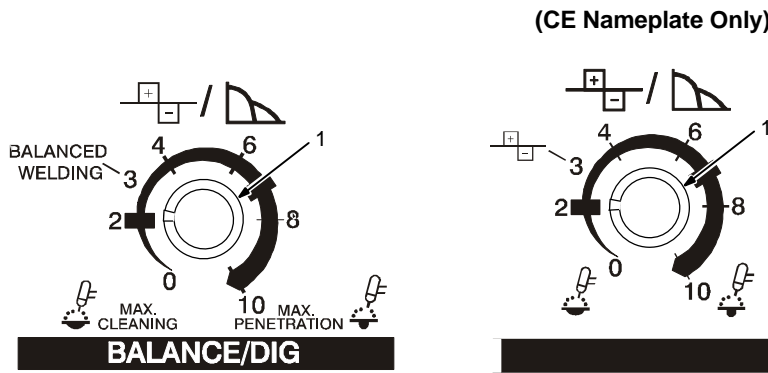

### 1 Balance/DIG Control

#### Balance Control (AC GTAW):

Control changes the AC output square wave. Rotating the control towards 10 provides deeper penetration. Rotating the control towards 0 provides more cleaning action of the workpiece.

When the control is in the Balanced position, the wave shape provides equal penetration and cleaning action.

#### Application:

When welding on oxide forming materials such as aluminum or magnesium, excess cleaning is not necessary. To produce a good weld, only a minimal amount, approximately a 0.10 in (2.5mm) of etched zone along the weld toes is required.

Set control to 7 and adjust as necessary. Joint configuration, set-up, process variables, and oxide thickness may affect setting.

Arc rectification can occur when welding above 200 amps and/or while welding with helium gas. If this condition occurs, increasing the Balance control towards maximum penetration, may help to restabilize the arc.







#### DIG Control (AC And DC SMAW):

When set at 0, short-circuit amperage at low arc voltage is the same as normal welding amperage.

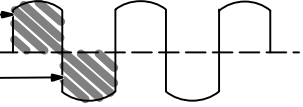
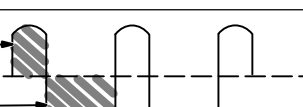
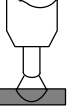
When setting is increased, short-circuit amperage at low arc voltage increases.

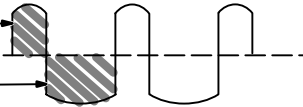
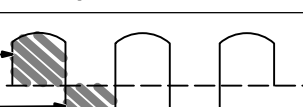
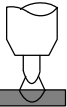
#### Application:

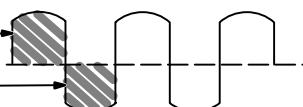
Control helps arc starting or making vertical or overhead welds by increasing amperage at low arc voltage, and reduces electrode sticking while welding.

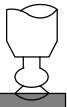
Balance Control Examples		
Setting	Output Waveforms	Arc
Balanced 	50% Electrode Positive  50% Electrode Negative 	
More Penetration 	32% Electrode Positive  68% Electrode Negative 	
More Cleaning 	55% Electrode Positive  45% Electrode Negative 	

Ref. S-0795-A

## 4-10. Preflow Time Control

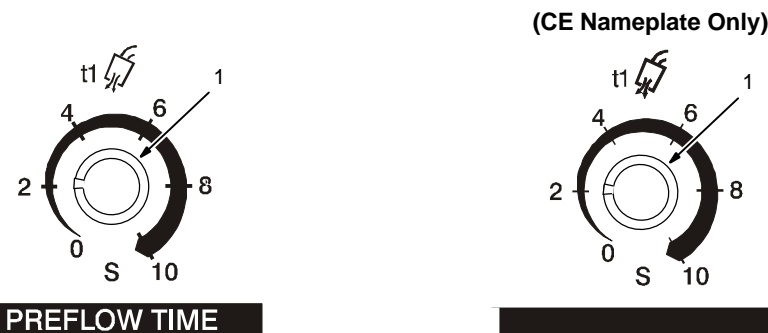

### 1 Preflow Time Control

Use control to set length of time that gas flows (0–10 seconds) before arc starts.

#### Application:

Preflow is used to purge the immediate weld area of atmosphere. Preflow also aids in consistent arc starting.

## 4-11. Postflow Time Control

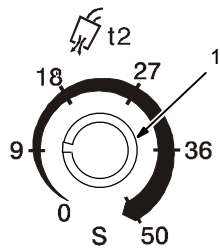

**POSTFLOW TIME**

(CE Nameplate Only)

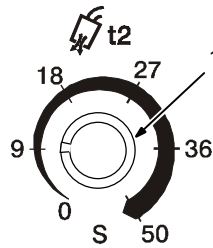

### 1 Postflow Time Control

Use control to set length of time (0–50 seconds) gas flows after welding stops. It is important to set enough time to allow gas to flow until after the tungsten and weld puddle has cooled down.

#### Application:

Postflow is required to cool tungsten and weld, and to prevent contamination of tungsten and weld. Increase postflow time if tungsten or weld are dark in appearance.



## 4-12. Setting Pulse Controls

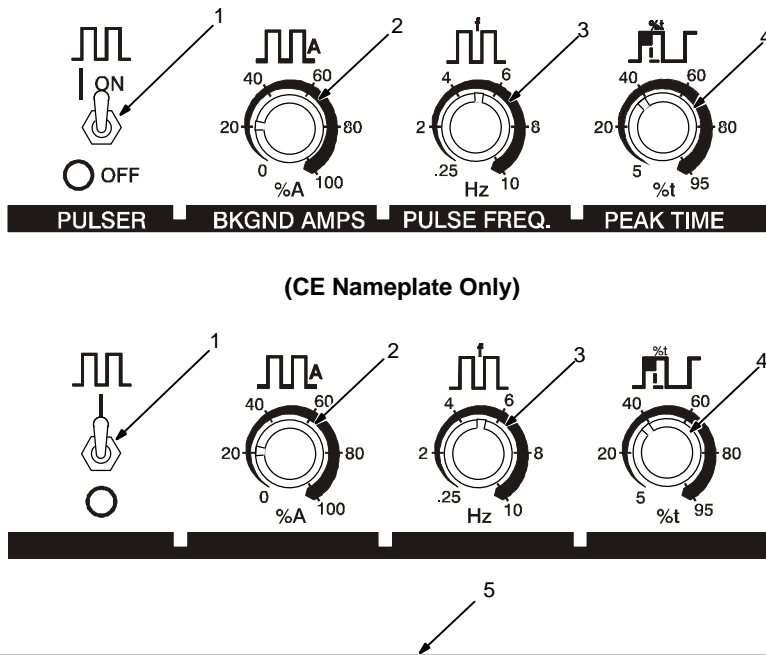

Percent (%) Peak Time Control Setting	Pulsed Output Waveforms
Balanced (50%) 	
More Time At Peak Amperage (80%) 	
More Time At Background Amperage (20%) 	

### 1 On/Off Switch

Use switch to turn pulse function On and Off.

### 2 Background Amps

Use Background Amps control to set the low pulse of the weld amperage, which cools the weld puddle and affects overall heat input. Background Amps is set as a percentage of peak amperage.

### 3 Pulse Frequency

A range from 0.25–10.0 pps (pulses per second). Control is used to determine appearance of weld bead.

### 4 Peak Time

A range of 5–95% of each pulse cycle can be spent at the peak amperage level.

Peak amperage (3–400 amps), is set with the Amperage Adjustment control (see Section A). Peak amperage is the highest welding amperage allowed to occur in the pulse cycle. Weld penetration varies directly with peak amperage.

### 5 Pulsed Output Waveforms

Example shows affect changing the Peak Time control has on the pulsed output waveform.

#### Application:

Pulsing refers to the alternating raising and lowering of the weld output at a specific rate. The raised portions of the weld output are controlled in width, height, and frequency, forming pulses of weld output. These pulses and the lower amperage level between them (called the background amperage) alternately heat and cool the molten weld puddle. The combined effect gives the operator better control of penetration, bead width, crowning, undercutting, and heat input. Controls can be adjusted while welding.

Pulsing can also be used for filler material addition technique training.

## 4-13. Optional Sequence Controls

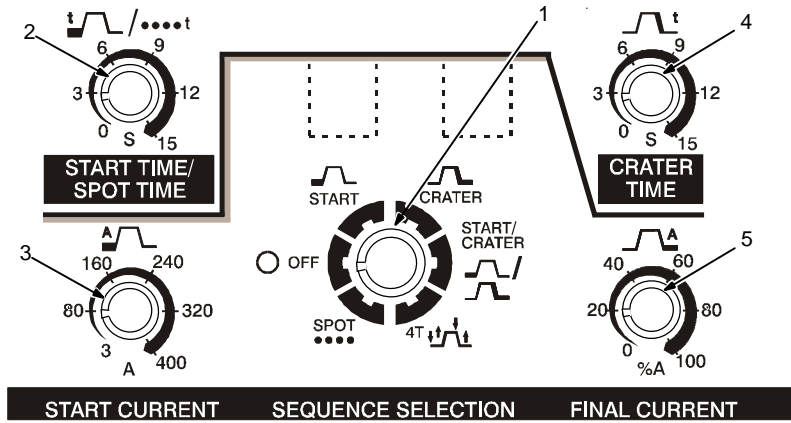

- 1 Sequence Selection Switch  
See Section 4-14.
- 2 Start Time/Spot Time Control  
See Section 4-15.
- 3 Start Current Control  
See Section 4-15.
- 4 Crater Time Control  
See Section 4-16.
- 5 Final Current Control  
See Section 4-16.

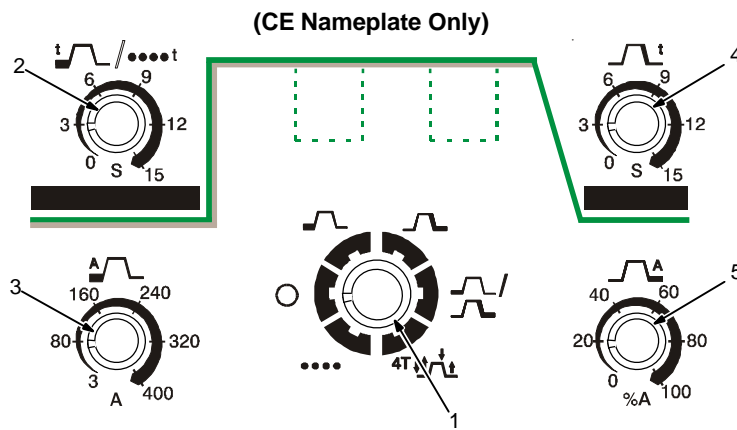

Ref. ST-191 372

## 4-14. Sequence Selection Switch

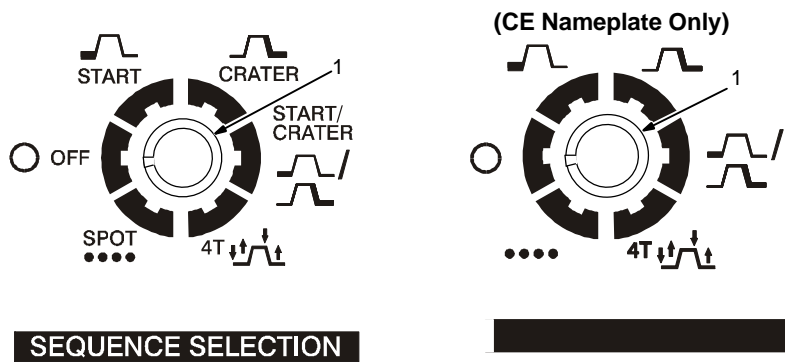

- 1 Sequence Selection Switch  
Switch controls Off, Start, Crater, Start/Crater, 4t, and Spot functions. Place switch in desired position.

**Off**– Place switch in Off position when Sequence Selection functions are not desired.

## 4-15. Start Time/Spot Time Control And Start Current Control

(CE Nameplate Only)

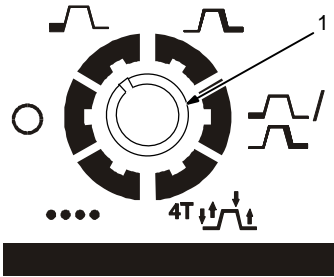
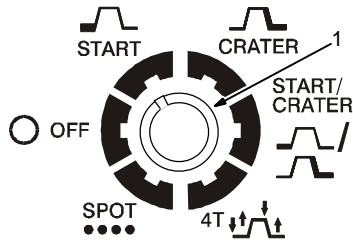

### SEQUENCE SELECTION

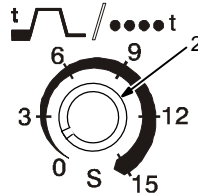
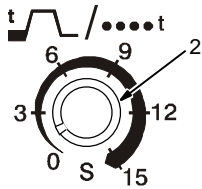

### START TIME/ SPOT TIME

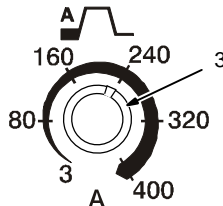
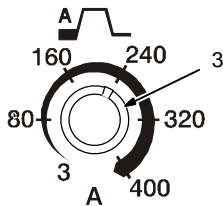

### START CURRENT

- 1 Sequence Selection Switch  
Place switch in Start position.
- 2 Start Time/Spot Time Control  
Use control to select 0–15 seconds of start time.
- 3 Start Current Control  
Use start control to select a starting current (3–400 amps) that is different from the weld current. Note: Start current can be used with or without a remote control.

#### Application:

Start current can be used while GTAW welding to assist in preheating cold material prior to depositing filler material, or to ensure a soft start. Start current can also be used for SMAW to ensure a more consistent arc strike.

## 4-16. Crater Time Control And Final Current Control

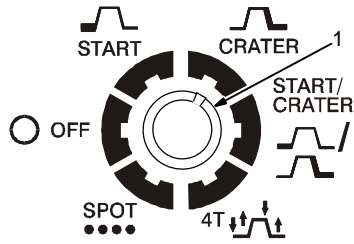

**SEQUENCE SELECTION**

(CE Nameplate Only)

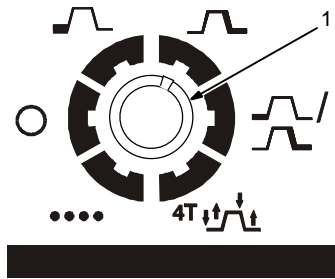

1 Sequence Selection Switch

Place switch in Crater position.

2 Crater Time Control

Use control to reduce current over a set period of time (0–15 seconds) at the end of the weld cycle when NOT using a remote current control.

3 Final Current Control

Final current is the current to which weld current has sloped down to (0–100% of current set on Amperage Adjust control).

**Application:**

Crater Time should be used while GTAW welding materials that are crack sensitive, and/or the operator wants to eliminate the crater at the end of the weld.

**Note:** This applies if the operator is using an on/off only type control to start and stop the welding process.

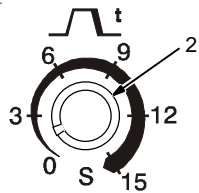

**CRATER TIME**

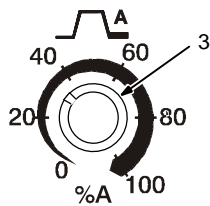
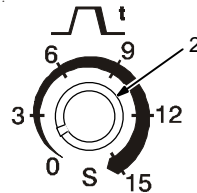

**FINAL CURRENT**

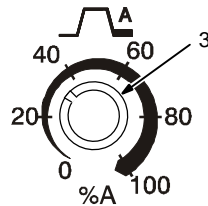

## 4-17. Start/Crater Sequence Controls

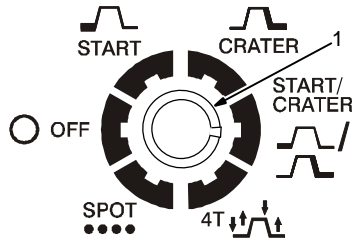

### SEQUENCE SELECTION

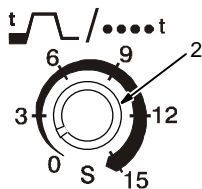

### START TIME/ SPOT TIME

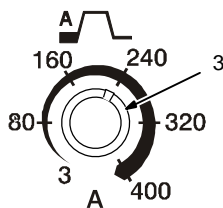

### START CURRENT

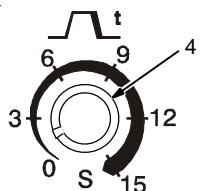

### CRATER TIME

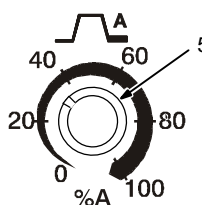

### FINAL CURRENT

(CE Nameplate Only)

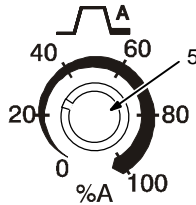
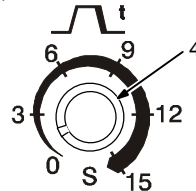
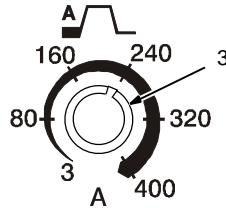
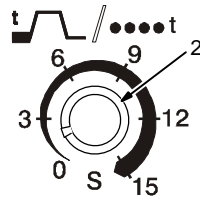
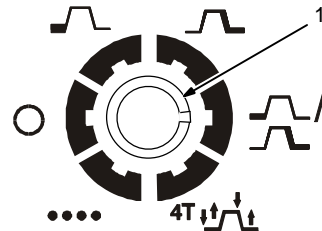

1 Sequence Selection Switch  
Place switch in Start/Crater position.

2 Start Time/Spot Time Control

Use control to select 0–15 seconds of start time.

3 Start Current Control

Use start control to select a starting current (3–400 amps) that is different from the weld current.

4 Crater Time Control

Use control to reduce current over a set period of time (0–15 seconds) at the end of the weld cycle when NOT using a remote current control.

5 Final Current Control

Final current is the current to which weld current has sloped down to (0–100% of current set on Amperage Adjust control).

#### Application:

Start current can be used while GTAW welding to assist in pre-heating a cold material prior to depositing filler material. Start current can also be used for SMAW to ensure a more consistent arc strike.

Crater Time can be used while GTAW welding when material being welded is crack sensitive, and the operator is using an on/off type control to start and stop the welding process.

**NOTE:** Use this method when the function of a remote control is desired, but only a remote on/off control is available.

## 4-18. 4T Sequence Selection Controls

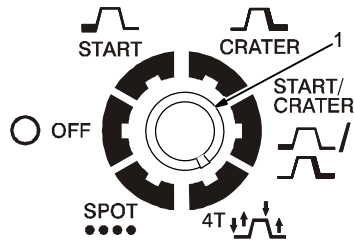

### SEQUENCE SELECTION

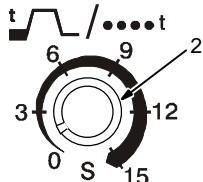

### START TIME/ SPOT TIME

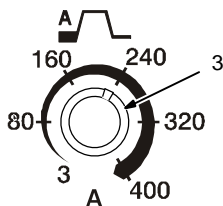

### START CURRENT

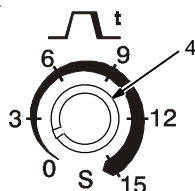

### CRATER TIME

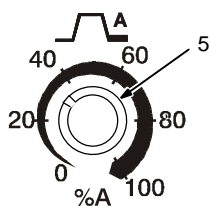

### FINAL CURRENT

(CE Nameplate Only)

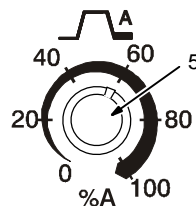
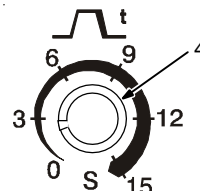
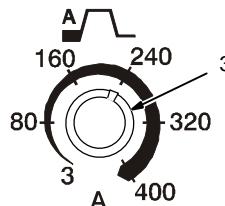
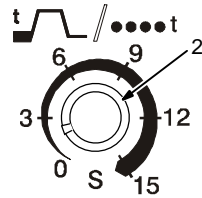
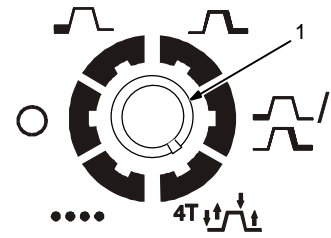

### 1 Start Sequence Switch – 4T Position

(Specific trigger method) Press and hold torch trigger to start Preweld Time and arc at the Start Current level. The arc will remain at the Start Current level as long as the trigger is depressed. Release trigger to change to main weld current. To end main weld current, press and hold trigger. Crater Time begins, and arc drops to Final Current level and remains there until trigger is released, at which time arc goes out, and Postflow Time begins.

While in 4T mode, there is a feature available during the main weld sequence that allows the operator to toggle between weld current and final current. To switch from weld current to final current, press and release torch trigger within 3/4 of a second. To return to weld current, press and release torch trigger within 3/4 of a second again.

### 2 Start Time/Spot Time Control

Use control to select 0–15 seconds of start time.

### 3 Start Current Control

Use start control to select a starting current (3–400 amps) that is different from the weld current.

### 4 Crater Time Control

Use control to reduce current over a set period of time (0–15 seconds) at the end of the weld cycle when not using a remote control.

### 5 Final Current Control

Final current is the current to which weld current has sloped up/down to (0–100% of current set on Amperage Adjust control).

### Application:

Use 4T trigger method when the functions of a remote current control are desired, but only a remote on/off control is available.

## 4-19. Spot Time Control

**SEQUENCE SELECTION**

**(CE Nameplate Only)**

**START TIME/SPOT TIME**

**1 Sequence Selection Switch – Spot Position**

Used with the (GTAW) TIG Spot process, generally with a direct current electrode negative (DCEN) set-up.

**2 Start Time/Spot Time Control**

Use control to select 0–15 seconds of spot time.

Use Amperage Adjust control (see Section 4-8) to set amperage.

**Application:**

TIG spot welding is used for joining thinner materials that are in close contact, with the fusion method. A good example would be joining coil ends.

## 4-20. Timer/Cycle Counter

**(CE Nameplate Only)**

**1 Current Control**

**2 Output (Contactor) Control**

To read timer/cycle counter, hold Current and Output (contactor) buttons while turning on power.

**3 Timer Display**







The hours and minutes are displayed on the volt and amp meters for the first five seconds, and are read as 1, 234 hours and 56 minutes.

**4 Cycle Display**

The cycles are displayed on the volt and amp meters for the next five seconds, and are read as 123, 456 cycles.

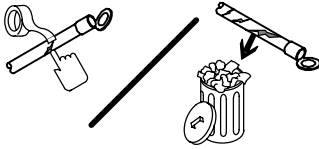
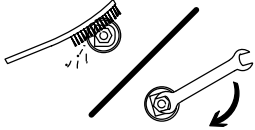
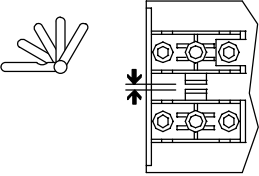
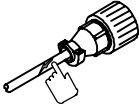
# SECTION 5 – MAINTENANCE & TROUBLESHOOTING

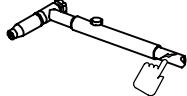
## 5-1. Routine Maintenance

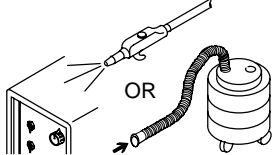
		<p>▲ Disconnect power before maintaining.</p>	
 <b>3 Months</b>			
	<p>Replace Unreadable Labels</p>		<p>Repair Or Replace Cracked Weld Cables</p>
			
	<p>Adjust Spark Gaps</p>		<p>14-Pin Cord</p>
			<p>Gas Hose</p>
			<p>Torch Cable</p>
			<p>Replace Cracked Parts</p>
 <b>6 Months</b>			
		<p>Blow Out Or Vacuum Inside, During Heavy Service, Clean Monthly</p> <p>▲ Warranty is void if machine fails due to contaminates inside.</p>	

## 5-2. Circuit Breaker CB1

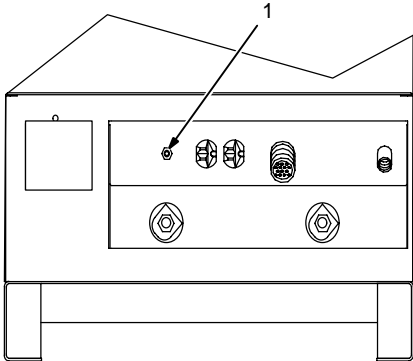
		<p>▲ Turn off power before resetting breaker.</p> <p>1 Circuit Breaker CB1</p> <p>If CB1 opens, high frequency and output to the 115 volts ac duplex receptacle stop. Press button to reset breaker.</p>
		

Ref. ST-801 972-C



## 5-3. Adjusting Spark Gaps

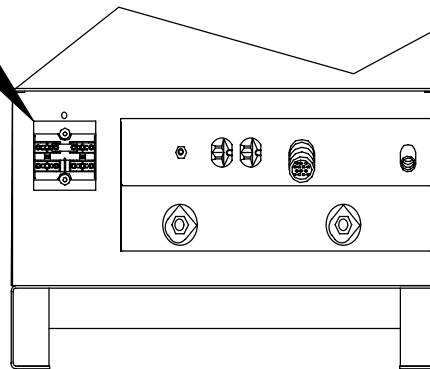
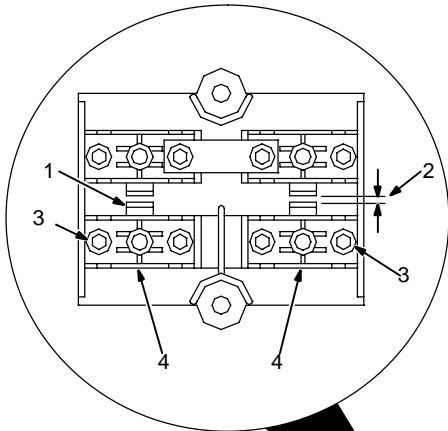

### Tools Needed:

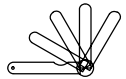

0.012 in (0.305 mm)

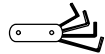
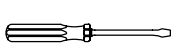

5/32 in

▲ Turn off welding power source and disconnect and lockout/tagout input power before adjusting spark gaps.

Open access door.

#### 1 Tungsten End Of Point

Replace point if tungsten end disappears; do not clean or dress tungsten.

#### 2 Spark Gap

Normal spark gap is 0.012 in (0.305 mm).

If adjustment is needed, proceed as follows:

#### 3 Adjustment Screws

Loosen screws. Place gauge of proper thickness in spark gap.

#### 4 Pressure Point

Apply slight pressure at point until gauge is held firmly in gap. Tighten screws to 12 in/lbs torque (overtightening will deform plastic base). Adjust other gap.

Reinstall access door.

Ref. ST-801 972-C

## 5-4. Voltmeter/Ammeter Help Displays

 All directions are in reference to the front of the unit. All circuitry referred to is located inside the unit.

### 0 Help 0 Display

Indicates a short in the thermal protection circuitry located on the transformer of the unit. If this display is shown, contact a Factory Authorized Service Agent.

### 1 Help 1 Display

Not used.

### 2 Help 2 Display

Indicates a malfunction in the thermal protection circuitry located on the transformer of the unit. If this display is shown, contact a Factory Authorized Service Agent.

### 3 Help 3 Display

Indicates the transformer of the unit has

overheated. The unit has shut down to allow the fan to cool it (see Section 3-4). Operation will continue when the unit has cooled.

### 4 Help 4 Display

Indicates a malfunction in the thermal protection circuitry located on the rectifier assembly of the unit. If this display is shown, contact a Factory Authorized Service Agent.

### 5 Help 5 Display

Indicates the rectifier assembly of the unit has overheated. The unit has shut down to allow the fan to cool it (see Section 3-4). Operation will continue when the unit has cooled.

### 6 Help 6 Display

Not used.

### 7 Help 7 Display

Not used.

### 8 Help 8 Display

Not used.

### 9 Help 9 Display

Indicates a short in the thermal protection circuitry located on the rectifier assembly of the unit. If this display is shown, contact a Factory Authorized Service Agent.

### 10 Help 10 Display

Indicates Remote Output control is activated. Release Remote Output control to clear help message.

### 11 Help 11 Display

Indicates Output Selector switch is not in correct position (see Section 4-2).

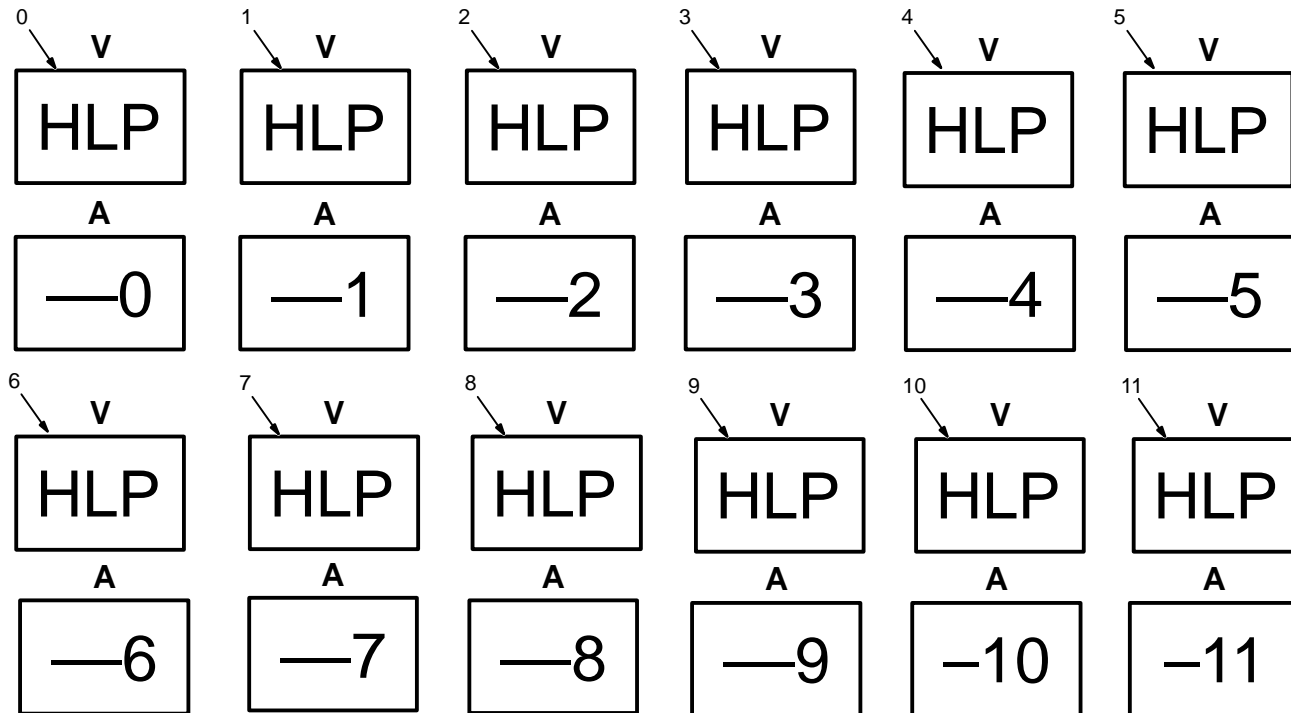

## 5-5. Troubleshooting

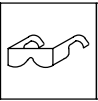

**NOTE:** The remedies listed below are recommendations only. If these remedies do not fix the trouble with your unit, have a Factory Authorized Service Agent check unit.  
**There are not user serviceable parts inside unit.**

Refer to Section 5-4 for any Help (HLP) message displayed on voltmeter/ammeter.

Trouble	Remedy
No weld output; unit completely inoperative.	Place line disconnect switch in On position (see Section 3-11).
	Check and replace line fuse(s), if necessary (see Section 3-11).
	Check for proper input power connections (see Section 3-11).
	Check for proper jumper link position (see Section 3-10).
No weld output; unit on.	If using remote control, place Output control in Remote 14 position, and make sure remote control is connected to Remote 14 receptacle. If remote is not being used, place Output control in On position (see Section 4-1).
	Check, repair, or replace remote control.
	Have Factory Authorized Service Agent check unit.
Unit provides only maximum or minimum weld output.	Make sure Amperage control is in proper position (see Section 4-1).
	Have Factory Authorized Service Agent check unit.
Erratic or improper weld output.	Use proper size and type of weld cable (see Section 3-6).
	Clean and tighten all weld connections.
	Check position of Output Selector control (see Section Figure 4-1).
	If using remote control, check position of Amperage Adjustment control (see Section 4-1).
No control of weld output.	If using remote control, place Output control in Remote 14 position, and make sure remote control is connected to Remote 14 receptacle. If remote is not being used, place Output control in On position (see Section 4-1).
	Make sure Amperage switch is in proper position (see Section 4-1).
No output from duplex receptacle RC2 and no high frequency.	Reset circuit breaker CB1 (see Section 5-2).
Lack of high frequency; difficulty in starting GTAW arc.	Reset circuit breaker CB1 (see Section 5-2).
	Select proper size tungsten.
	Be sure torch cable is not close to any grounded metal.
	Check cables and torch for cracked insulation or bad connections. Repair or replace.
	Check spark gaps (see Section 5-3).
Wandering arc – poor control of direction of arc.	Reduce gas flow rate.
	Select proper size tungsten.
	Properly prepare tungsten.
Tungsten electrode oxidizing and not remaining bright after conclusion of weld.	Shield weld zone from drafts.
	Increase postflow time.
	Check and tighten all gas fittings.
	Properly prepare tungsten.
	Check for water in torch, and repair torch if necessary.
Fan not operating.	Unit equipped with Fan-On-Demand™. Fans run only when necessary. Unit equipped with circuitry to protect against overheating.



# SECTION 6 – ELECTRICAL DIAGRAM

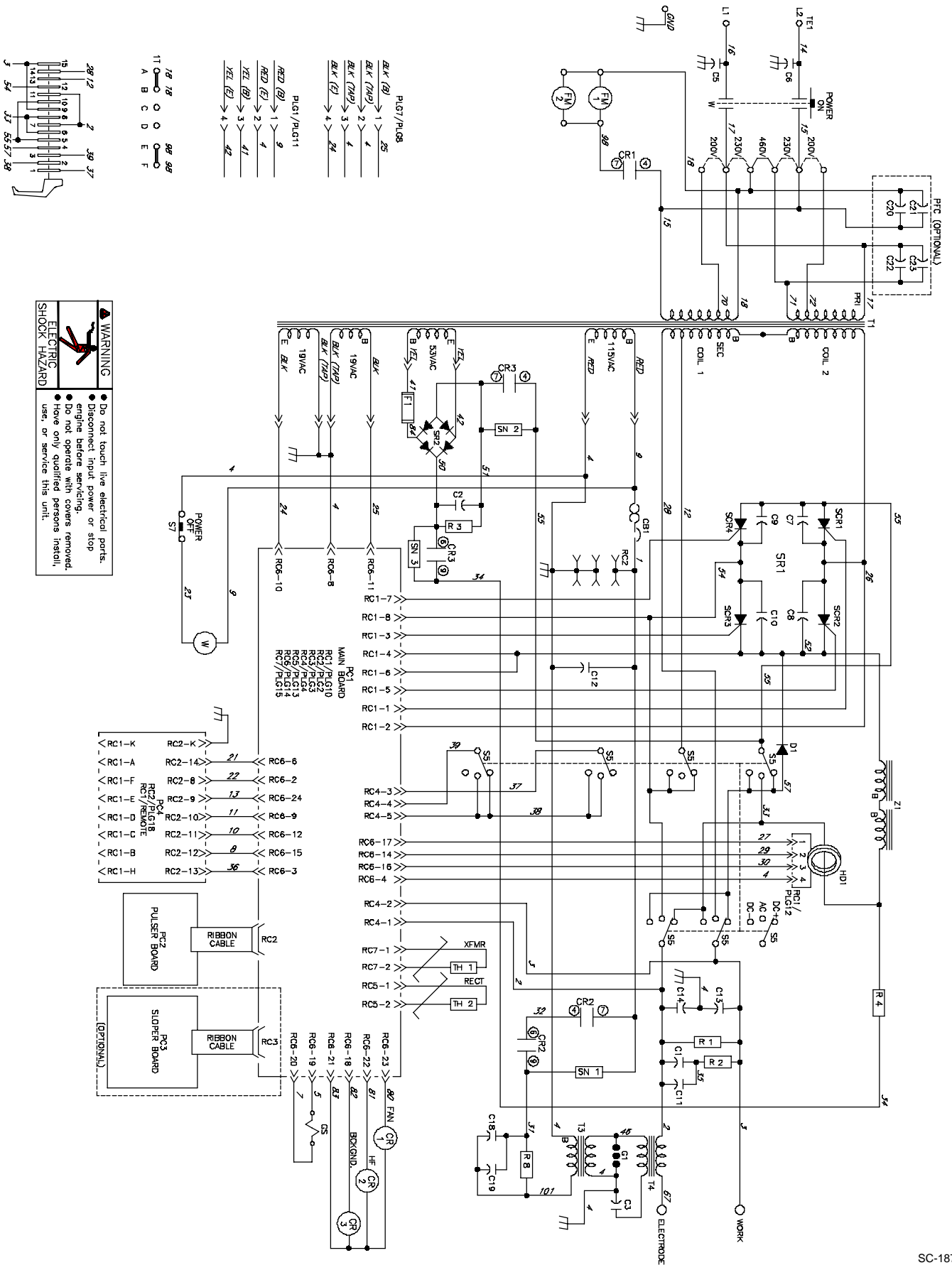
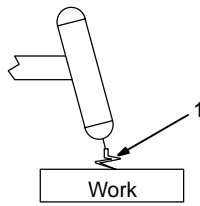

Figure 6-1. Circuit Diagram

# SECTION 7 – HIGH FREQUENCY

## 7-1. Welding Processes Requiring High Frequency



Work

TIG

1 High-Frequency Voltage

TIG – helps arc jump air gap between torch and workpiece and/or stabilize the arc.

high\_freq 12/96 – S-0693

## 7-2. Incorrect Installation

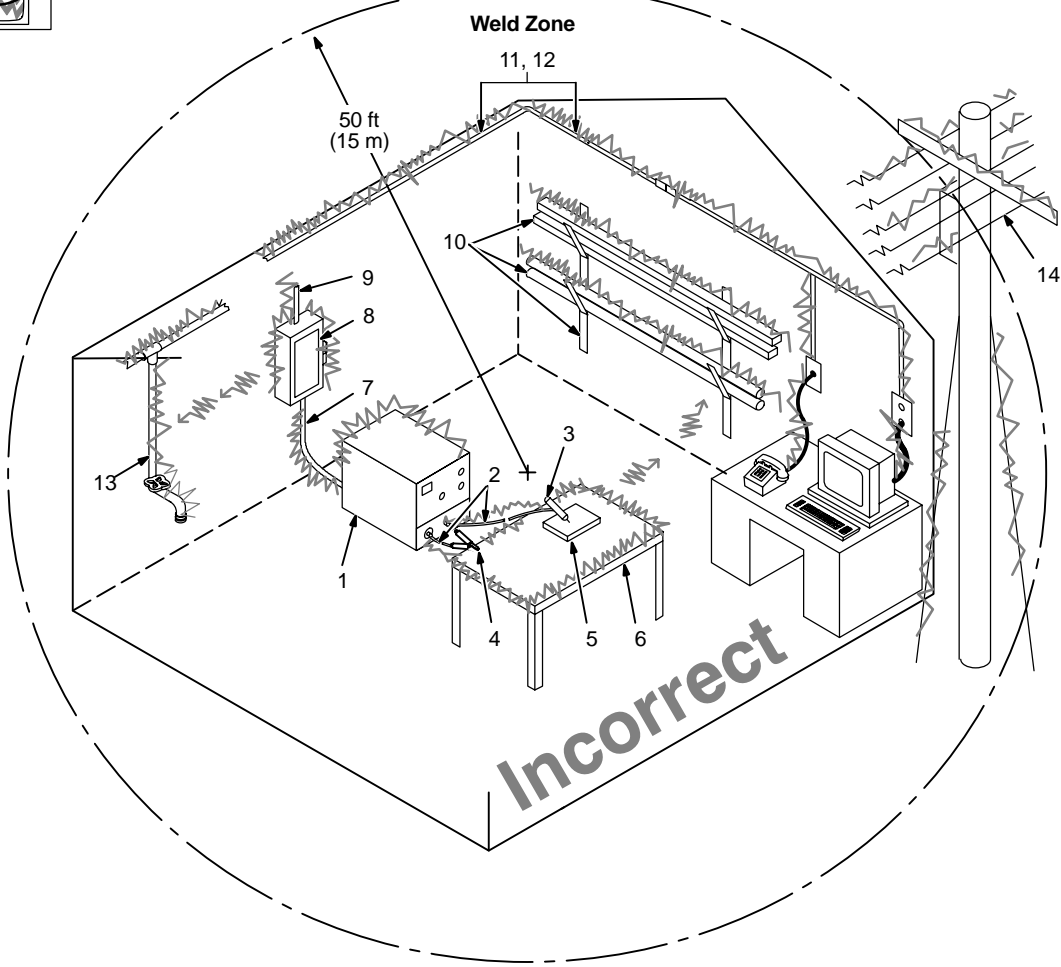

### Sources of Direct High-Frequency Radiation

- 1 High-Frequency Source (welding power source with built-in HF or separate HF unit)
- 2 Weld Cables
- 3 Torch
- 4 Work Clamp
- 5 Workpiece
- 6 Work Table

### Sources of Conduction of High Frequency

- 7 Input Power Cable
- 8 Line Disconnect Device
- 9 Input Supply Wiring

### Sources of Reradiation of High Frequency

- 10 Ungrounded Metal Objects
- 11 Lighting
- 12 Wiring
- 13 Water Pipes and Fixtures
- 14 External Phone and Power Lines

S-0694

## 7-3. Correct Installation

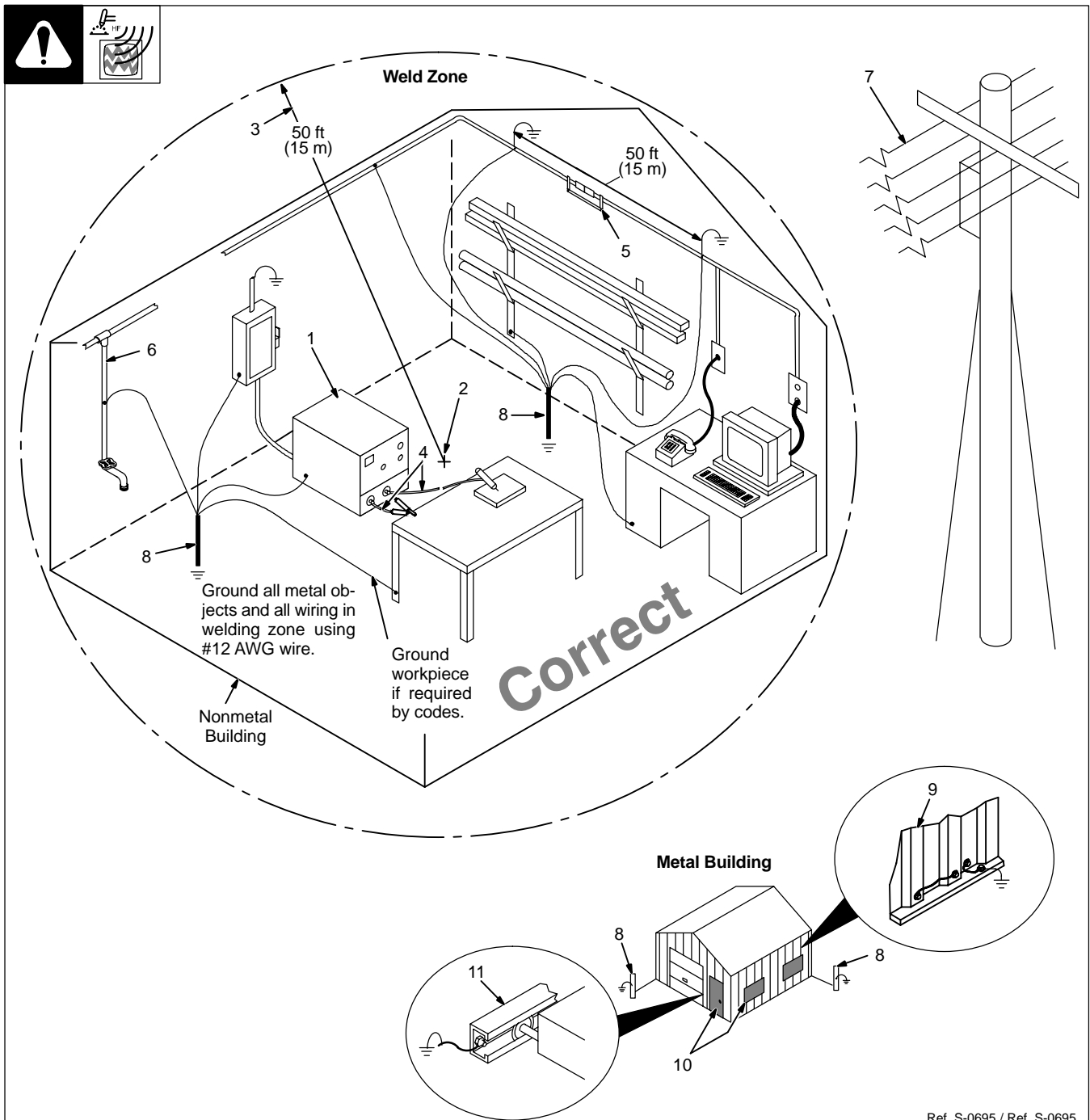

Ref. S-0695 / Ref. S-0695

- 1 High-Frequency Source (welding power source with built-in HF or separate HF unit)

Ground metal machine case, work output terminal, line disconnect device, input supply, and worktable.

- 2 Center Point of Welding Zone

Midpoint between high-frequency source and welding torch.

- 3 Welding Zone

A circle 50 ft (15 m) from center point in all directions.

- 4 Weld Output Cables

Keep cables short and close together.

- 5 Conduit Joint Bonding and Grounding

Electrically join (bond) all conduit sections using copper straps or braided wire. Ground conduit every 50 ft (15 m).

- 6 Water Pipes and Fixtures

Ground water pipes every 50 ft (15 m).

- 7 External Power or Telephone Lines

Locate high-frequency source at least 50 ft (15 m) away from power and phone lines.

- 8 Grounding Rod

Consult the National Electrical Code for specifications.

### Metal Building Requirements

- 9 Metal Building Panel Bonding Methods

Bolt or weld building panels together, install copper straps or braided wire across seams, and ground frame.

- 10 Windows and Doorways

Cover all windows and doorways with grounded copper screen of not more than 1/4 in (6.4 mm) mesh.

- 11 Overhead Door Track

Ground the track.

# SECTION 8 – PARTS LIST

 Hardware is common and not available unless listed.

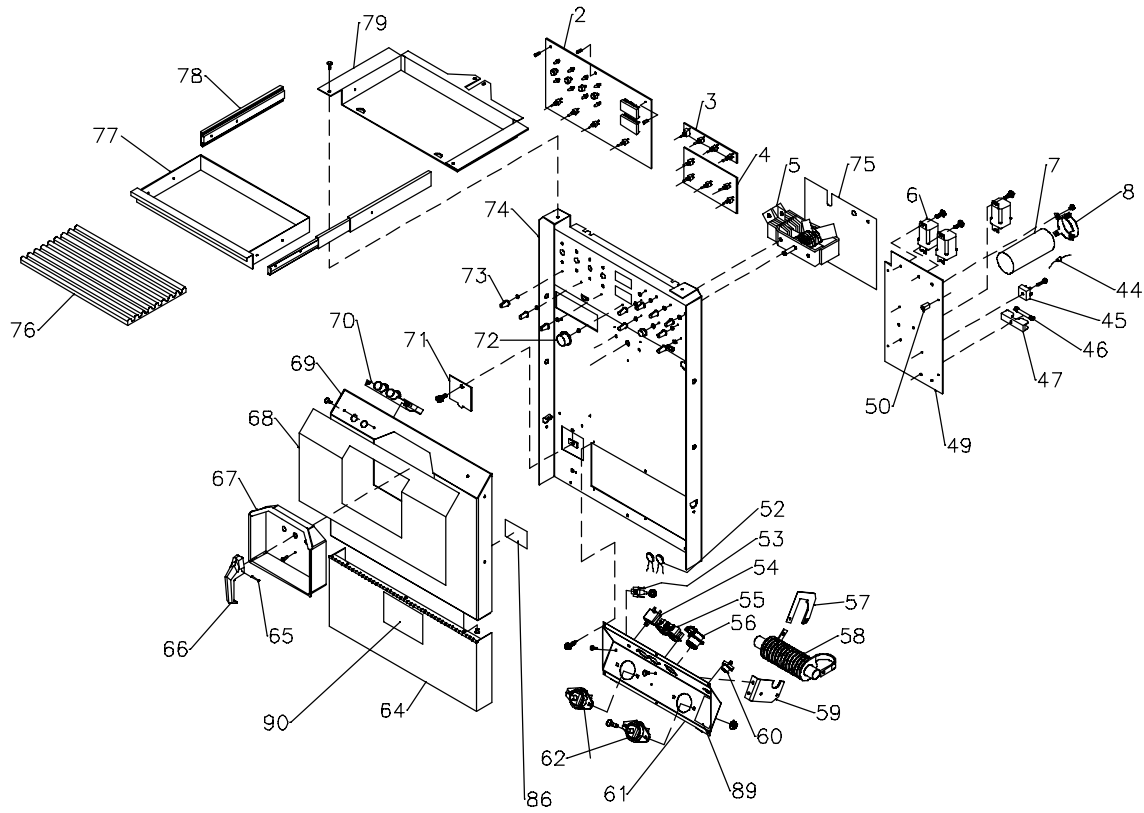
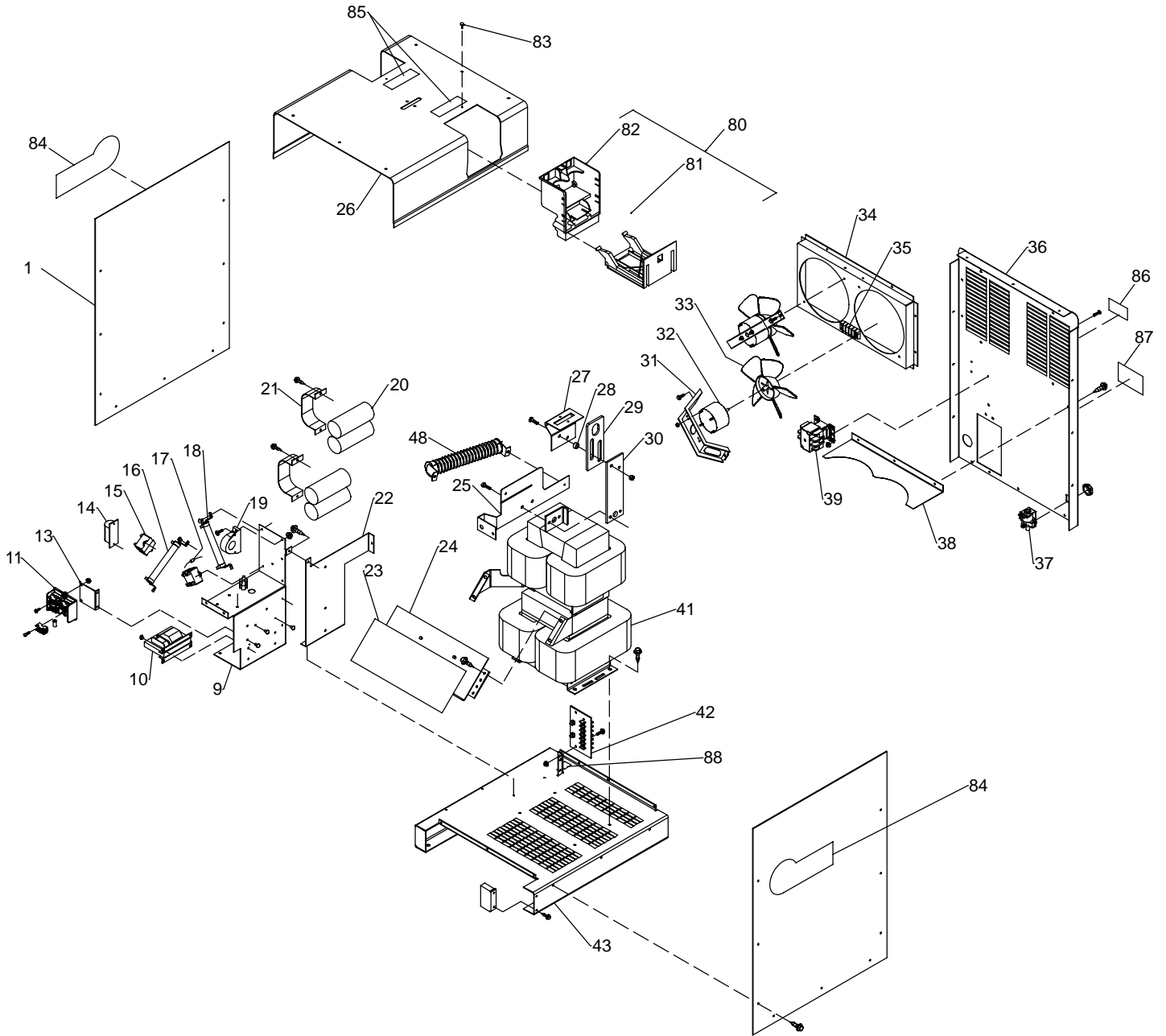

Figure 8-1. Main Assembly





Item No.	Dia. Mkgs.	Part No.	Description	Quantity
<b>Figure 8-1. Main Assembly</b>				
1		204 659	PANEL, side	2
2	PC1	196 254	CIRCUIT CARD, interface (consisting of)	1
		186 914	7 SEGMENT LED DISPLAY (LED's 18 - 23)	6
	PLG13, 15	131 054	CONNECTOR W/SOCKETS	2
	PLG10	165 484	CONNECTOR W/SOCKETS	1
	PLG4	131 055	CONNECTOR W/SOCKETS	1
	PLG14	167 333	CONNECTOR W/SOCKETS	1
		190 512	STAND-OFF, No. 6-32 x .645lg	3
3	PC2	183 101	CIRCUIT CARD, pulser	1
4	PC3	◆ 183 105	CIRCUIT CARD, timer	1
5	S5	187 467	SWITCH, polarity	1
		021 795	TUBING, stl .375 OD x 18ga	2
	PLG4	131 055	CONNECTOR & SOCKETS	1
6	CR1-3	052 964	RELAY, encl 24VDC DPDT	3
	SN1-3	118 625	SNUBBER	3
7	C2	031 668	CAPACITOR, electlt 4000uf 100 VDC	1
		168 976	INSULATOR, capacitor	1
8		108 105	CLAMP, capacitor	2
9		184 067	CONTROL BOX, HF	1
10	T3	208 045	TRANSFORMER, high voltage 115 V pri 3600 V sec 30 mA w/term	1
11	G1	199 854	SPARK GAP ASSEMBLY (consisting of)	1
		199 856	HOLDER, points	1
		196 455	POINT, spark gap	4
		199 855	BASE, spark gap	1
		184 068	BRACKET, spark gap	1
14	C3	096 761	CAPACITOR, mica .002uf 10,000 V pnl mtg	1
15	C1.11, 18, 19	191 944	CAPACITOR, polyp met film 10uf 250 VAC	4
16	R8	188 067	RESISTOR, ww fxd 100 W 200 ohm w/clips	1
17	R2	189 132	RESISTOR ASSEMBLY	1
18	R1	186 468	RESISTOR, ww fxd 100W 50 ohm	1
19	HD1	168 829	TRANSDUCER, current 1000A	1
20	C20-23	◆ 203 520	CAPACITOR. polyp film 200 uf 250 VAC can 10%	4
21		◆ 129 201	BRACKET, mtg capacitor	2
22		201 072	BAFFLE, cap power factor	1
23		187 447	BAFFLE, air	1
24	SR1	211 346	RECTIFIER, si diode	1
25		202 856	BRACKET, switch	1
26		205 726	COVER, top	1
27		187 806	BRACKET, lift eye	1
28		155 903	BUSHING, lift eye	2
29		155 905	LIFT, eye	1
30		204 294	SUPPORT, lift eye	1
31		187 807	FAN BRACKET	2
32	FM1,2	148 808	MOTOR, fan 230 V 1550 RPM	2
33		150 783	BLADE, fan 9.000 5wg	2
34		184 058	FAN PLENUM	1
35		199 312	BLOCK, terminal fast-on	1
		108 023	LINK, jumper	2
36		208 803	PANEL, rear	1
		010 467	CONNECTOR, clamp cable	1
		184 057	DOOR, pri	1
37	GS	133 873	VALVE, 24 VDC 2way custom port 1/8 orf	1
		605 227	NUT, .750-14	1
38		184 060	BAFFLE, panel rear	1
39		187 416	CONTACTOR w/BRACKET	1
41		192 574	TRANSFORMER/STABILIZER ASSEMBLY 200/230/460	1
41		192 577	TRANSFORMER/STABILIZER ASSEMBLY 230/460/575	1
41		191 562	TRANSFORMER/STABILIZER ASSEMBLY 220/400/440/520	1
	TH1	188 431	THERMISTER, NTC	1

Item No.	Dia. Mkgs.	Part No.	Description	Quantity
<b>Figure 8-1. Main Assembly (Continued)</b>				
42	TE1	202 790	TERMINAL ASSEMBLY, pri 1ph 3V (consisting of)	1
		083 426	TERMINAL BOARD, pri	1
		038 618	LINK, jumper term bd pri	2
		601 835	NUT, brs hex 10-32reg	12
		601 836	NUT, brs hex .250-20 jam hvy	4
		038 888	STUD, pri board brs .250-20 x 1.500	2
		038 887	STUD, pri board brs 10-32 x 1.375	6
		010 913	WASHER, flat brs .187 ID	6
		010 915	WASHER, flat brs .250 ID x .625 OD x .031thk	4
		602 207	WASHER, lock .255 ID x .489 OD	2
		175 479	LINK, jumper	1
	C5,6	111 634	CAPACITOR	1
43		208 801	BASE	1
44	R3	118 459	RESISTOR, ww fxd 10W 1K ohm	1
45	SR2	035 704	RECTIFIER, integ 40A 800V	1
46	F1	085 874	FUSE, mintr slo-blo 10A 250V	1
47		172 731	HOLDER, fuse mintr .250 x 1.250 clip	1
48	R4	186 949	RESISTOR, ww fxd 175W 20 ohm	1
49		184 061	PANEL, relay	1
50		083 147	GROMMET, scr No. 8/10	4
52	C13,14	187 254	CAPACITOR ASSEMBLY	2
53		208 294	CONNECTOR, Faston male 4-prong	1
54	CB1	093 995	CIRCUIT BREAKER, man reset 1P 250 VAC	1
55	RC2	189 033	RECEPTACLE, str dx grd 2P3W 15A 125V	1
	C12	135 664	CAPACITOR, cer disc .01uf 500VAC	1
56	RC2	211 911	CONN, circ ms/cpc 14 skt size 20 rctpt w/filtering	1
	PLG18	165 484	CONNECTOR & SOCKETS	1
57		157 317	HOLDER, HF coil	1
58	T4	212 255	COIL, HF coupling	1
59		157 318	HOLDER, HF coil	1
60		120 854	FITTING, gas	1
61		213 222	LOWER HF PANEL	1
62		039 047	TERMINAL, pwr output red	2
64		+184 050	DOOR ASSEMBLY HF PANEL	1
		134 327	LABEL, warning general precautionary	1
		127 363	LABEL, warning electric shock can kill	1
65		169 136	PIN, handle	1
66		175 952	HANDLE, switch	1
67		192 547	RECESS, handle switch	1
68		183 260	NAMEPLATE, (order by model & serial number)	1
69		191 009	PANEL, switch	1
70	S7	185 196	SWITCH, push button (Figure 8-2)	1
71		184 066	DOOR, spark gap access	1
72		174 991	KNOB, pointer	As Rq'd
73		183 332	KNOB, pointer	As Rq'd
		195 778	ACTUATOR, push button switch	4
74		212 246	PANEL, front	1
		183 200	PLATE, indicator syncrowave	1
75		190 311	BAFFLE, switch	1
76		204 416	DRAWER, mat	1
77		204 314	DRAWER	1
78		204 307	SLIDE, drawer	2
79		204 313	DRAWER, tray	1
80		204 389	HOLDER, torch/cable (consisting of)	2
81		200 920	DOOR, torch/cable holder	2
82		200 922	HOUSING, torch/cable holder	2
83		494 907	SCREW, k50 x 20 pan hd - trx stl pld pt thread forming	2

Item No.	Dia. Mkgs.	Part No.	Description	Quantity
----------	------------	----------	-------------	----------

**Figure 8-1. Main Assembly (Continued)**

... 84	...	213 287	... LABEL, MILLER 12.563 x 5.376 horizontal	2
... 85	...	201 019	... LABEL, warning electric shock excess weight	2
... 86	...	127 363	... LABEL, warning electric shock can kill	2
... 87	...	168 384	... LABEL, warning electric shock and incorrect input	1
... 88	...	155 436	... LABEL, ground/protective earth	1
... 89	...	206 344	... LABEL, do not connect two cables	1
... 90	...	203 990	... LABEL, warning general precautionary static	1

◆ **OPTIONAL**

+When ordering a component originally displaying a precautionary label, the label should also be ordered.

**To maintain the factory original performance of your equipment, use only Manufacturer's Suggested Replacement Parts. Model and serial number required when ordering parts from your local distributor.**

☞ *Hardware is common and not available unless listed.*

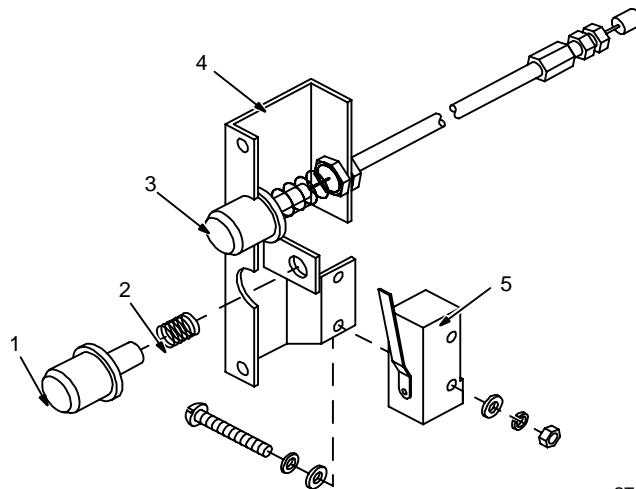

ST-080 214-B

**Figure 8-2. Switch, Push Button**

Item No.	Dia. Mkgs.	Part No.	Description	Quantity
----------	------------	----------	-------------	----------

**S7      185 196      Figure 8-2. Switch, Push Button (Fig 8-1 Item 70)**

... 1	...	059 885	... BUTTON, push reset red	1
... 2	...	018 606	... SPRING, compression	1
... 3	...	186 303	... PUSH BUTTON, w/cable and housing	1
... 4	...	081 008	... BRACKET, mtg switch PB	1
... 5	...	178 856	... SWITCH, limit leaf actuating SPDT	1





# TRUE BLUE<sup>®</sup>

## WARRANTY

Effective January 1, 2002

(Equipment with a serial number preface of "LC" or newer)

This limited warranty supersedes all previous Miller warranties and is exclusive with no other guarantees or warranties expressed or implied.

### Warranty Questions?

Call  
1-800-4-A-MILLER  
for your local  
Miller distributor.

Your distributor also gives  
you ...

#### Service

You always get the fast,  
reliable response you  
need. Most replacement  
parts can be in your  
hands in 24 hours.

#### Support

Need fast answers to the  
tough welding questions?  
Contact your distributor.  
The expertise of the  
distributor and Miller is  
there to help you, every  
step of the way.

**LIMITED WARRANTY** – Subject to the terms and conditions below, Miller Electric Mfg. Co., Appleton, Wisconsin, warrants to its original retail purchaser that new Miller equipment sold after the effective date of this limited warranty is free of defects in material and workmanship at the time it is shipped by Miller. THIS WARRANTY IS EXPRESSLY IN LIEU OF ALL OTHER WARRANTIES, EXPRESS OR IMPLIED, INCLUDING THE WARRANTIES OF MERCHANTABILITY AND FITNESS.

Within the warranty periods listed below, Miller will repair or replace any warranted parts or components that fail due to such defects in material or workmanship. Miller must be notified in writing within thirty (30) days of such defect or failure, at which time Miller will provide instructions on the warranty claim procedures to be followed.

Miller shall honor warranty claims on warranted equipment listed below in the event of such a failure within the warranty time periods. All warranty time periods start on the date that the equipment was delivered to the original retail purchaser, or one year after the equipment is sent to a North American distributor or eighteen months after the equipment is sent to an International distributor.

1. 5 Years Parts — 3 Years Labor
  - \* Original main power rectifiers
  - \* Inverters (input and output rectifiers only)
2. 3 Years — Parts and Labor
  - \* Transformer/Rectifier Power Sources
  - \* Plasma Arc Cutting Power Sources
  - \* Semi-Automatic and Automatic Wire Feeders
  - \* Inverter Power Supplies
  - \* Intelligig
  - \* Engine Driven Welding Generators  
**(NOTE: Engines are warranted separately by the engine manufacturer.)**
3. 1 Year — Parts and Labor Unless Specified
  - \* DS-2 Wire Feeder
  - \* Motor Driven Guns (w/exception of Spoolmate Spoolguns)
  - \* Process Controllers
  - \* Positioners and Controllers
  - \* Automatic Motion Devices
  - \* RFCS Foot Controls
  - \* Induction Heating Power Sources
  - \* Water Coolant Systems
  - \* Flowgauge and Flowmeter Regulators (No Labor)
  - \* HF Units
  - \* Grids
  - \* Maxstar 85, 140
  - \* Spot Welders
  - \* Load Banks
  - \* Racks
  - \* Running Gear/Trailers
  - \* Plasma Cutting Torches (except APT & SAF Models)
  - \* Field Options  
**(NOTE: Field options are covered under True Blue<sup>®</sup> for the remaining warranty period of the product they are installed in, or for a minimum of one year — whichever is greater.)**
4. 6 Months — Batteries
5. 90 Days — Parts
  - \* MIG Guns/TIG Torches
  - \* Induction Heating Coils and Blankets

- \* APT, ZIPCUT & PLAZCUT Model Plasma Cutting Torches
- \* Remote Controls
- \* Accessory Kits
- \* Replacement Parts (No labor)
- \* Spoolmate Spoolguns
- \* Canvas Covers

Miller's True Blue<sup>®</sup> Limited Warranty shall not apply to:

1. **Consumable components; such as contact tips, cutting nozzles, contactors, brushes, slip rings, relays or parts that fail due to normal wear. (Exception: brushes, slip rings, and relays are covered on Bobcat, Trailblazer, and Legend models.)**
2. Items furnished by Miller, but manufactured by others, such as engines or trade accessories. These items are covered by the manufacturer's warranty, if any.
3. Equipment that has been modified by any party other than Miller, or equipment that has been improperly installed, improperly operated or misused based upon industry standards, or equipment which has not had reasonable and necessary maintenance, or equipment which has been used for operation outside of the specifications for the equipment.

MILLER PRODUCTS ARE INTENDED FOR PURCHASE AND USE BY COMMERCIAL/INDUSTRIAL USERS AND PERSONS TRAINED AND EXPERIENCED IN THE USE AND MAINTENANCE OF WELDING EQUIPMENT.

In the event of a warranty claim covered by this warranty, the exclusive remedies shall be, at Miller's option: (1) repair; or (2) replacement; or, where authorized in writing by Miller in appropriate cases, (3) the reasonable cost of repair or replacement at an authorized Miller service station; or (4) payment of or credit for the purchase price (less reasonable depreciation based upon actual use) upon return of the goods at customer's risk and expense. Miller's option of repair or replacement will be F.O.B., Factory at Appleton, Wisconsin, or F.O.B. at a Miller authorized service facility as determined by Miller. Therefore no compensation or reimbursement for transportation costs of any kind will be allowed.

TO THE EXTENT PERMITTED BY LAW, THE REMEDIES PROVIDED HEREIN ARE THE SOLE AND EXCLUSIVE REMEDIES. IN NO EVENT SHALL MILLER BE LIABLE FOR DIRECT, INDIRECT, SPECIAL, INCIDENTAL OR CONSEQUENTIAL DAMAGES (INCLUDING LOSS OF PROFIT), WHETHER BASED ON CONTRACT, TORT OR ANY OTHER LEGAL THEORY.

ANY EXPRESS WARRANTY NOT PROVIDED HEREIN AND ANY IMPLIED WARRANTY, GUARANTY OR REPRESENTATION AS TO PERFORMANCE, AND ANY REMEDY FOR BREACH OF CONTRACT TORT OR ANY OTHER LEGAL THEORY WHICH, BUT FOR THIS PROVISION, MIGHT ARISE BY IMPLICATION, OPERATION OF LAW, CUSTOM OF TRADE OR COURSE OF DEALING, INCLUDING ANY IMPLIED WARRANTY OF MERCHANTABILITY OR FITNESS FOR PARTICULAR PURPOSE, WITH RESPECT TO ANY AND ALL EQUIPMENT FURNISHED BY MILLER IS EXCLUDED AND DISCLAIMED BY MILLER.

Some states in the U.S.A. do not allow limitations of how long an implied warranty lasts, or the exclusion of incidental, indirect, special or consequential damages, so the above limitation or exclusion may not apply to you. This warranty provides specific legal rights, and other rights may be available, but may vary from state to state.

In Canada, legislation in some provinces provides for certain additional warranties or remedies other than as stated herein, and to the extent that they may not be waived, the limitations and exclusions set out above may not apply. This Limited Warranty provides specific legal rights, and other rights may be available, but may vary from province to province.





# Owner's Record

Please complete and retain with your personal records.

---

Model Name Serial/Style Number

---

Purchase Date (Date which equipment was delivered to original customer.)

---

Distributor

---

Address

---

City

---

State Zip

---



## For Service

**Call 1-800-4-A-Miller or see our website at [www.MillerWelds.com](http://www.MillerWelds.com) to locate a DISTRIBUTOR or SERVICE AGENCY near you.**

Always provide Model Name and Serial/Style Number.

- 
- |                               |  |
|-------------------------------|--|
| Contact your Distributor for: | <ul style="list-style-type: none"> <li>Welding Supplies and Consumables</li> <li>Options and Accessories</li> <li>Personal Safety Equipment</li> <li>Service and Repair</li> <li>Replacement Parts</li> <li>Training (Schools, Videos, Books)</li> <li>Technical Manuals (Servicing Information and Parts)</li> <li>Circuit Diagrams</li> <li>Welding Process Handbooks</li> </ul> |
|-------------------------------|--|

Contact the Delivering Carrier for: File a claim for loss or damage during shipment.

For assistance in filing or settling claims, contact your distributor and/or equipment manufacturer's Transportation Department.

### Miller Electric Mfg. Co.

An Illinois Tool Works Company  
1635 West Spencer Street  
Appleton, WI 54914 USA

### International Headquarters—USA

USA Phone: 920-735-4505 Auto-Attended  
USA & Canada FAX: 920-735-4134  
International FAX: 920-735-4125

### European Headquarters – United Kingdom

Phone: 44 (0) 1204-593493  
FAX: 44 (0) 1204-598066

[www.MillerWelds.com](http://www.MillerWelds.com)

